

AutoCAD LT

Tips Guide



AutoCAD LT Tips Guide

SETUP & BASICS

1. Keyboard Shortcuts
2. Autosave
3. Quick Access Toolbar
4. Right-click
5. Layers
6. Draw Order

VIEWING

7. Zoom
8. Display Plot Styles
9. Shared Views

OBJECTS

10. Object Snaps
11. Isolate Objects
12. Associative Arrays
13. Dimensions

MODIFYING

14. Match Properties
15. Dynamic Blocks
16. Group
17. DWG Compare

ANNOTATION

18. Multiline Text
19. Spell Checker
20. Find and Replace
21. QuickCalc

DATA MANAGEMENT

22. External References
23. eTransmit
24. PDF Import
25. Sheet Set Manager

ECOSYSTEM

26. AutoCAD Web App
27. AutoCAD Mobile App

MINDSET

28. Make Mistakes
29. You Do You



**setup
& basics**

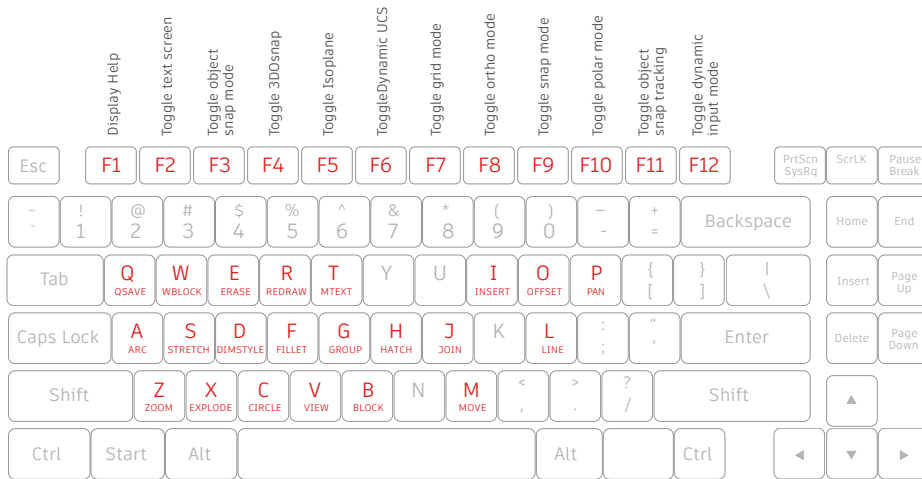

Keyboard Shortcuts

Take advantage of AutoCAD-LT-specific keyboard shortcuts to save you valuable time. You can even create or modify the existing shortcuts.

1. Click Manage tab > Customization panel > User Interface, or type CUI into the command line.
2. In the Customize tab, Customization in All Files pane, click the plus sign (+) next to the Keyboard Shortcuts node to expand it.
3. Click the plus sign (+) next to the Shortcut Keys.
 - To create a shortcut key, in the Command List pane, drag a command to the Shortcut Keys node in the Customization in All Files pane.
 - To modify a shortcut key, select a shortcut key from under the Shortcut Keys node.

FILE SAFETY PRECAUTIONS

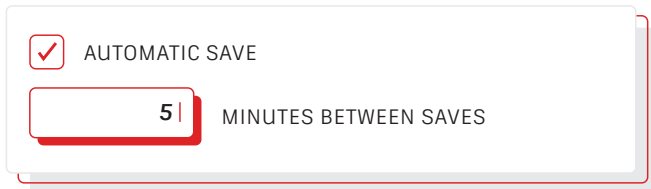

AUTOMATIC SAVE

MINUTES BETWEEN SAVES

Autosave

Set your Autosave setting to 5 minutes (or 2 or 3 minutes!), and manually save often with the QSAVE command or Ctrl+S shortcut.

Automatic save files are backup files created automatically by the Autosave feature. Set the number of minutes between automatic saves in the Open and Save tab in the Options dialog box or by using the SAVETIME command. Automatic saves are only done if a drawing has been modified after the last save. QSAVE, SAVE, and SAVEAS will delete the current .sv\$ file – the Autosave file only remains if the application closes unexpectedly.

Find the location of your autosave files by going to the Files tab in the Options dialog box and inspecting the Automatic Save File Location folder in the hierarchy, or by using the SAVEFILEPATH command. Once you find the file, change the file extension from .sv\$ to .dwg to open.

BONUS: *If you don't see any file extensions when looking for your Autosave file, you'll need to turn them on. Do so by checking the File Name Extensions box in the Show/Hide panel of the View tab.*

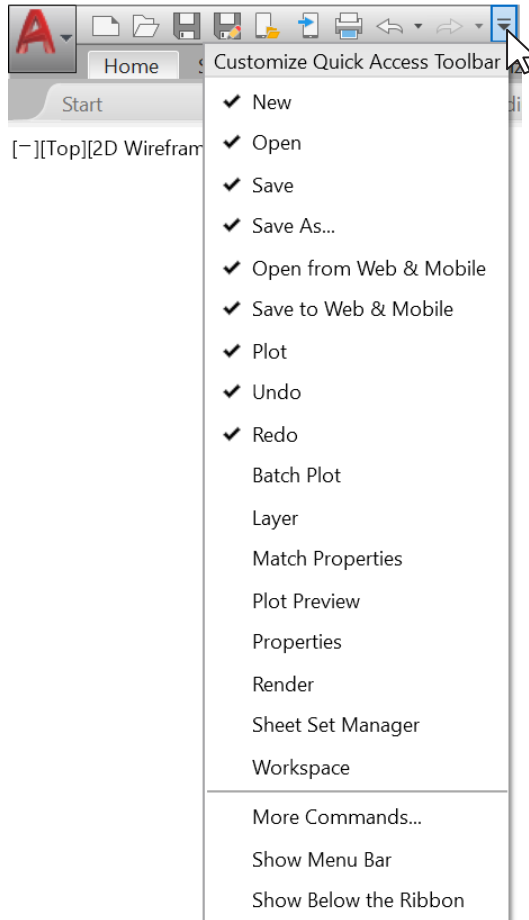

Quick Access Toolbar

Keep your most frequently used tools in the Quick Access Toolbar (QAT) right at the top of your screen. Customize the QAT by clicking the small, pull-down control button on the right. You can check and un-check the commands you want quick access to.

Here, you can also change where the Quick Access Toolbar docks, or even turn on the old-style Menu Bar. You can also drag the elements within the Quick Access Toolbar to change the order in which they appear.

BONUS: For a fast way to add a Ribbon command to the Quick Access toolbar, right-click any command icon on the Ribbon, and then select *Add to Quick Access Toolbar* from the popup menu. Similarly, right-click on any Quick Access Toolbar item to remove it.

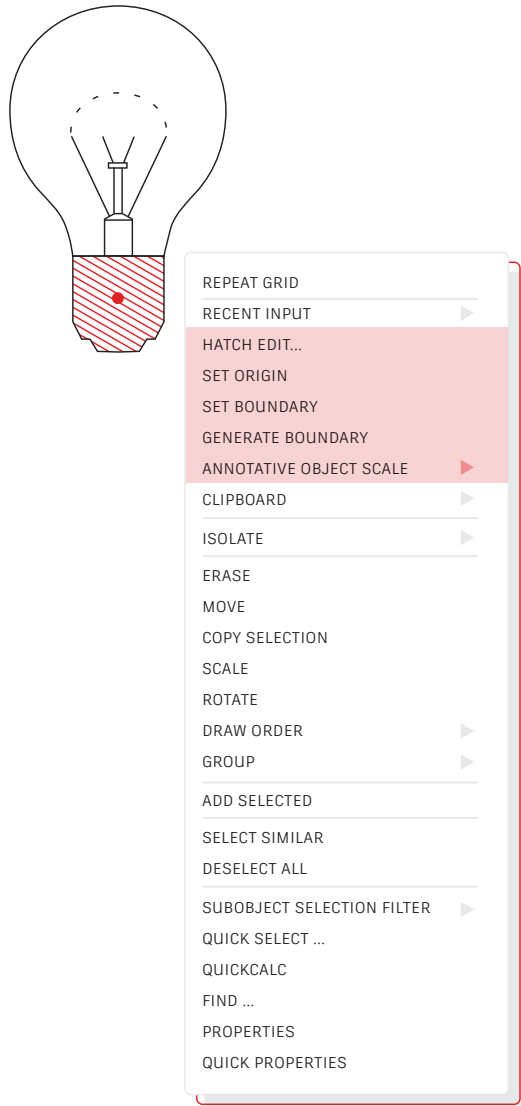

Right-Click

Right-click to access contextual popup menus, a productivity enhancement favorite. Since the menus are contextual, you get commands that are specific to what's selected.

If you're someone who uses a mouse right-click as ENTER, you can still have the best of both worlds. It's easy using this time sensitive right-click feature. To turn it on, simply call up the Options dialog box, go to the User Preferences tab, and then select the Right-Click Customization button. You'll get a second dialog box that contains the control for time-sensitive right-clicks.

When enabled, right-click will still function as you prefer, with a single, quick click working as ENTER, but now, by holding down the mouse button just a little longer – a quarter of a second by default – you'll get the contextual popup menu instead.

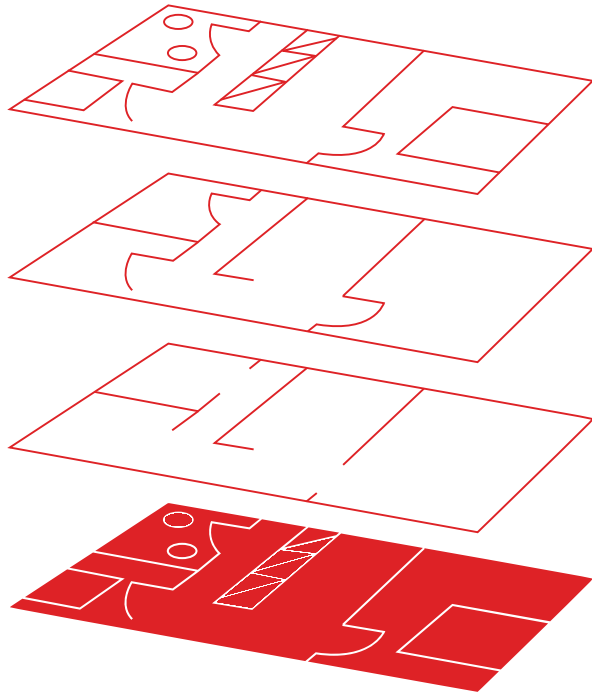

Layers

Resist the temptation to create everything on one layer. Organize your drawings by assigning objects to layers that are associated with a specific function or purpose, for example, walls on one layer and doors on another layer.

With layers, you can:

- Associate objects by their function or location
- Display or hide all related objects in a single operation
- Specify linetype, color, line weight, and other standards for each layer

To see how a drawing is organized, use the LAYER command to open the Layer Properties Manager. You can either enter LAYER or LA in the Command window, or you can click the Layer Properties tool on the Home tab of the Ribbon.

BONUS: Got lots of Xrefs and therefore lots of layers? Increase the MAXSORT variable (from its default of 1000) so all your layers can sort correctly.

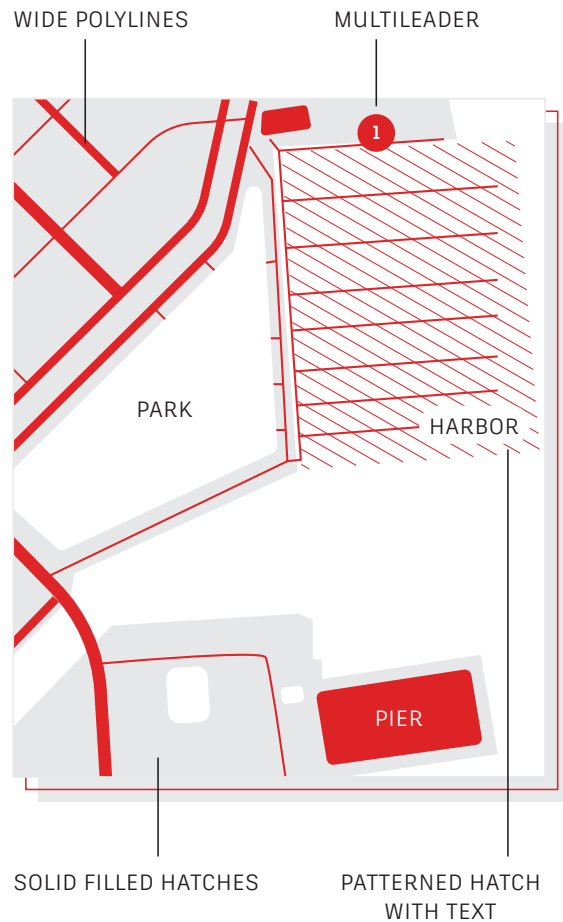

Draw Order

Control how objects overlap and the order in which they're displayed with the Draw Order command. Set up your Draw Order with “Bring Annotations to Front” and “Send Hatch to Back”.

In the Home tab of the Ribbon, click the Modify panel drop-down list, and select Draw Order (or use the DRAWORDER command). Choose one of the displayed options, select the objects you want to modify, and press Enter.

In general, you will want to display and plot annotation objects in front of other objects, and hatches and fills behind. Wipeout objects are intended to provide a blank area for adding text without modifying the objects underneath.

NOTE: You can control the draw order of overlapping objects only within the same space: model space or paper space.

viewing

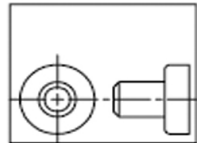

before ZOOM All

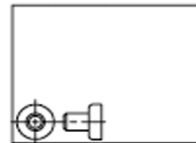

after ZOOM All

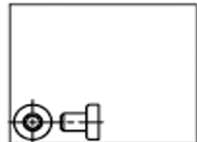

before ZOOM Extents

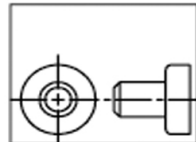

after ZOOM Extents

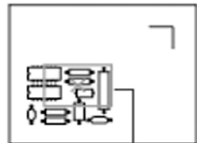

view box

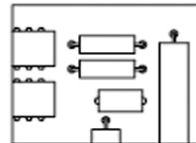

new view

Zoom

Follow the prompts displayed after the ZOOM command to view your drawing exactly how you wish. “ZOOM > All” adjusts the magnification of the drawing area to show all visible objects or the drawing limits set with the LIMITS command. “ZOOM > Extents” displays the maximum extent of all objects.

“ZOOM > Dynamic” pans and zooms using a rectangular view box. The view box represents your view, which you can shrink or enlarge and move around the drawing. Positioning and sizing the view box pans or zooms to fill the viewport with the view inside the view box. (This is not available in perspective projection.)

BONUS #1: If you have a mouse with a wheel, double-click the mouse wheel to activate Zoom Extents.

BONUS #2: Use the command VTENABLE to turn off smooth view transitions which occur during panning and zooming. Setting it to 0 (zero) turns it off for pan/zoom, rotation, and scripts.

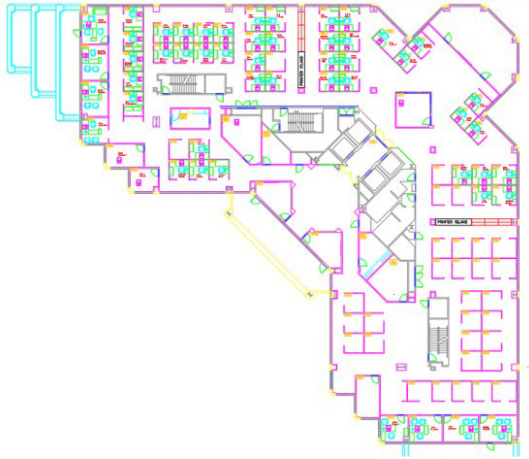

Display Plot Styles

View your drawing in AutoCAD LT as it's going to look when it's printed by selecting "Display Plot Styles" in the Page Setup dialog box.

AutoCAD LT displays drawings in color and then translates the drawing data to a different printed format. Typically, we need to do a plot preview to see what the layout is going to look like when plotted, but you can change this via Display Plot Styles. Set your main layout in this way or create a separate layout to act as a "live" preview so that you can still work in your traditional colored layout view.

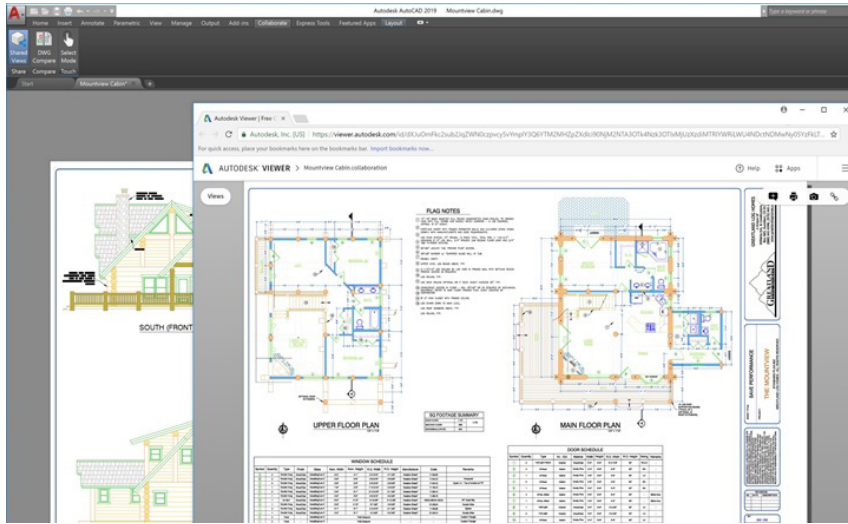

Shared Views

Share designs easily within or outside your company using the Shared Views feature – without releasing your original DWG files. Instead of a PDF, share a link that can be viewed and commented on in any browser.

Avoid the cumbersome commonly-used workflow of publishing and emailing designs via DWF or PDF files. Instead, a viewable file is created in AutoCAD LT and circulated via a shareable link that can be viewed and commented on in the browser of any device with internet access. Comments that collaborators make on the shared link appear right back in your AutoCAD LT desktop product.

The Shared Views feature can be accessed from AutoCAD LT's Application menu, under Publish.

NOTE: Shared Views automatically expire after 30 days, but you can extend or terminate the link at any time.

objects

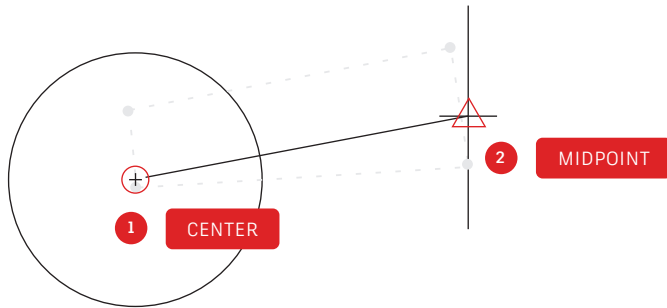

Object Snaps

Use Object Snaps (OSNAP) to draw objects precisely in relation to other objects in your drawing. For example, you can use object snaps to create a line from the center of a circle to the midpoint of another line.

You can specify an object snap whenever you are prompted for a point. By default, a marker and a tooltip are displayed when you move the cursor over an object snap location.

To specify an object snap at a prompt for a point, you can:

- Press Shift and Right-click to display the Object Snap shortcut menu
- Right-click and choose an object snap from the Snap Overrides submenu
- Enter the name of an object snap
- Click an object snap button on the Object Snap toolbar. This will turn on running object snaps that will persist through all subsequent commands.

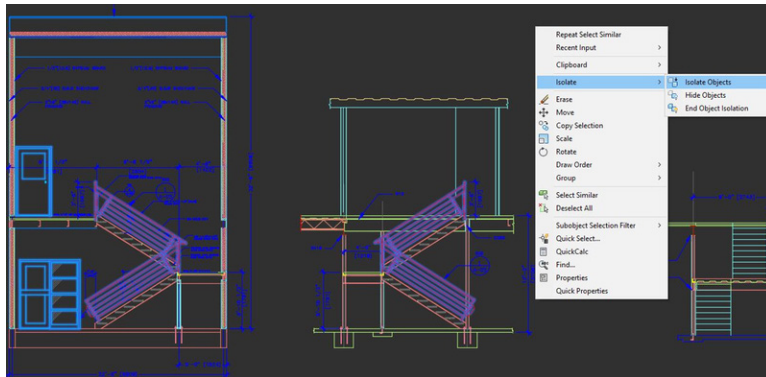

Isolate Objects

Isolate a selected group of objects for easier editing in complicated or busy drawings. The Isolate Objects tool (**ISOLATEOBJECTS**) makes non-selected objects in the drawing temporarily invisible.

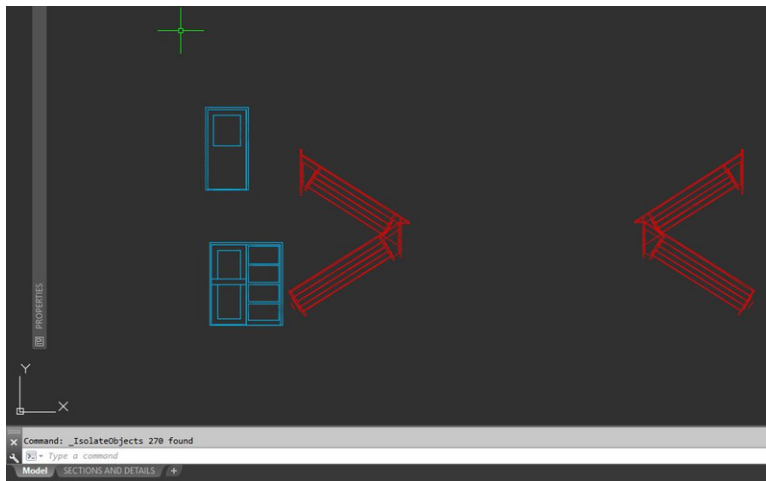

Start this command from the Right-click menu or by typing **ISOLATEOBJECTS** into the command line. When you are finished editing or working in the cleaned area of your drawing, you can end your object isolation and bring back any hidden objects simply by using the **UNISOLATEOBJECTS** command or End Object Isolation right-click option.

BONUS #1: Hide objects instead to clear up an area of a busy drawing by using the **HIDEOBJECTS** command or in the right-click menu to temporarily suppress selected objects.

BONUS #2: By default, hidden or isolated objects are temporary during your current drawing session. However, if you set **OBJECTISOLATIONMODE** to 1, the hidden or isolated objects will persist between sessions.

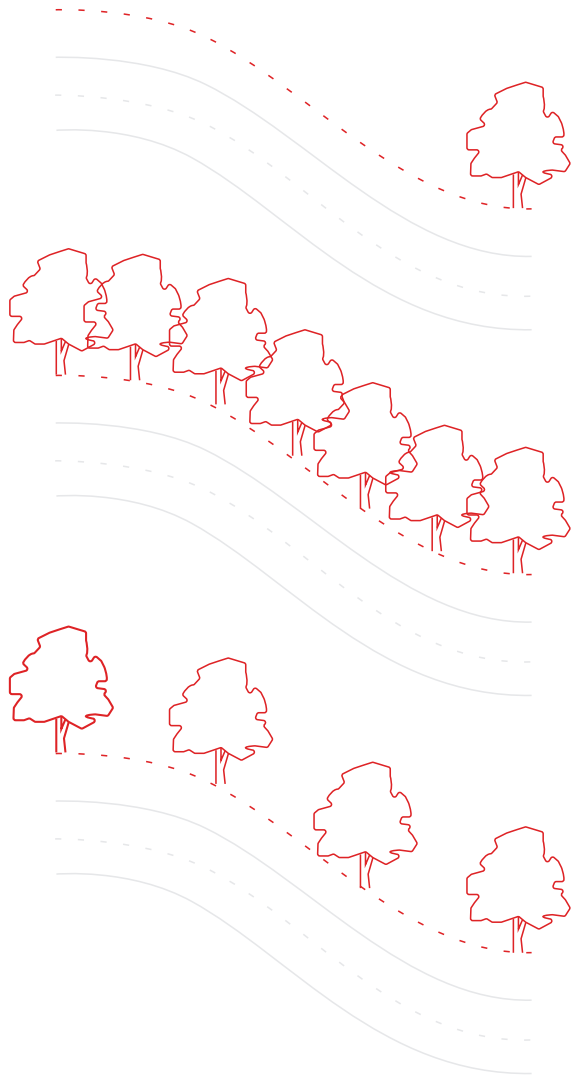

Associative Arrays

Use associative arrays, where objects within arrays retain their relationships. It's incredibly easy to make adjustments to an array pattern, spacing, and location – and much faster than changing the location of individual objects.

Many designs contain symmetrical or repeatable patterns. Repeatable patterns, also known as arrays, can be created using the ARRAY command. Associative arrays make it easy to create rectangular and polar patterns along with distributing items along a 2D path.

Once an associative array has been created, you can:

- Replace all instances of the original object
- Replace or edit individual objects in an array
- Update the number of and distance between items in an array

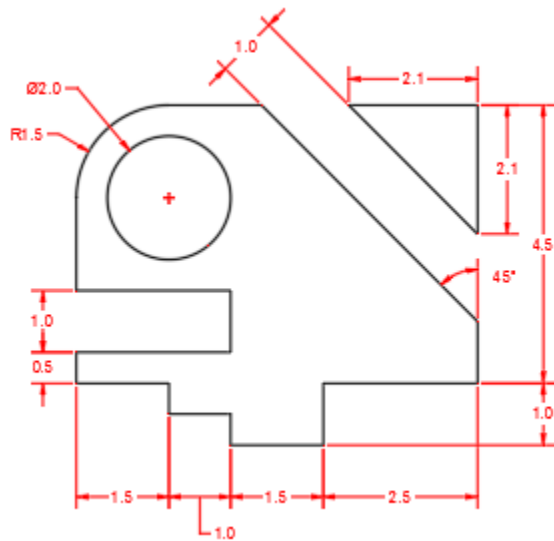

Dimensions

Save time by using the single DIM command to create one dimension after another without interruption and without typing multiple commands.

Type DIM into the command line or find the Dimension tool in the Annotate tab of the Ribbon. This command allows you to achieve different results with a combination of:

- The DIM option you choose
- The type of object you hover over
- Where you hover over an object
- Where you pick or click
- What direction you move the cursor

BONUS: Cut more time out of your workflow by using the QDIM command to apply dimensions to an entire series of objects at once.

modifying

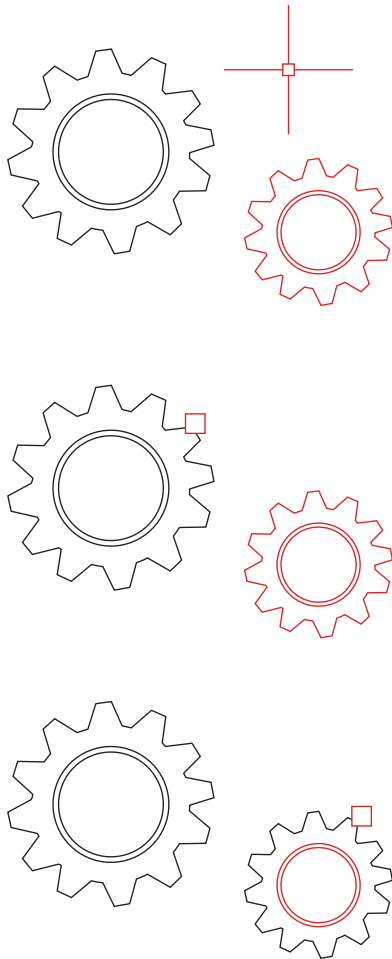

Match Properties

Copy properties from one object to another using Match Properties (MATCHPROP). The types of properties that can be matched include color, layer, linetype, linetype scale, lineweight, plot style, transparency, and other special properties.

1. Click Home tab > Properties panel > Match Properties or type MATCHPROP into the command line.
2. Select the source object from which you want to copy properties.
3. Select the target objects to which you want to copy the properties, and press Enter.

BONUS: Specify what properties you want matched in the Property Settings dialog box. For example, disable the Text (style) property when you want to match the layer between two pieces of text. After Step 2 above, enter S (Settings). In the Property Settings dialog box, clear the properties that you do not want copied, and click OK.

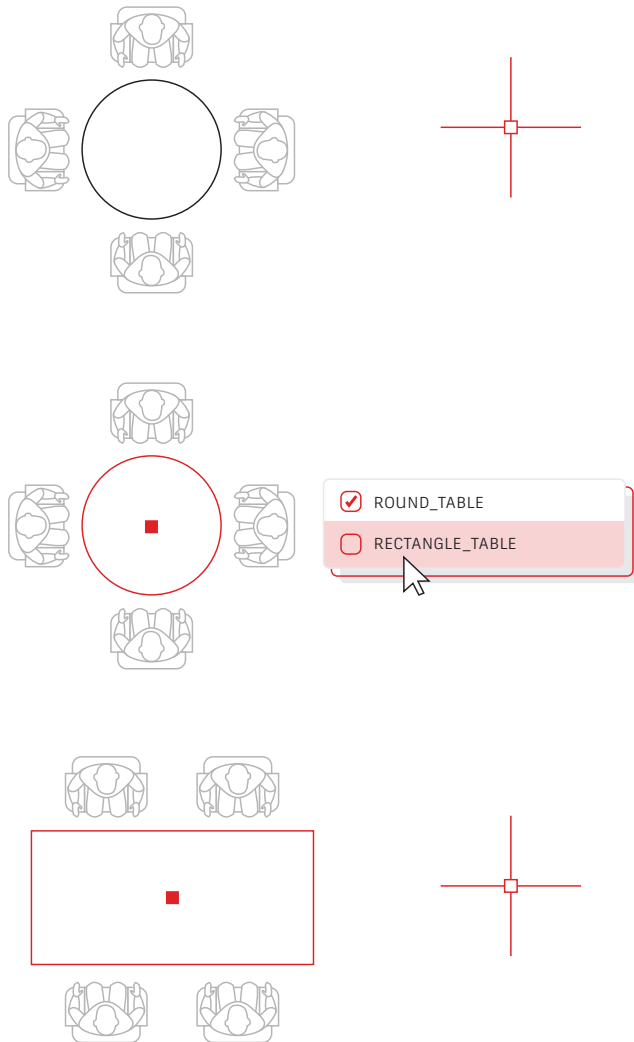

Dynamic Blocks

Save time and decrease file size by utilizing Dynamic Blocks. Create one block that can change shape, size, or configuration depending on their usage instead of inserting multiple static blocks.

For example, instead of creating multiple blocks for different table types and chair settings, you can create one table block. Once the block is inserted, you can select the table type at any time. You can also define dynamic blocks that can be stretched, rotated, flipped, and more.

1. Click Insert tab > Block Definition panel > Create Block.
2. Back in the drawing, double-click the block and select OK on the Edit Block Definition dialog. This opens the Block Editor environment and the Block Editor Ribbon tab.
3. Add constraints, actions, and parameters (rules) using the Properties palette from within the Block Editor.

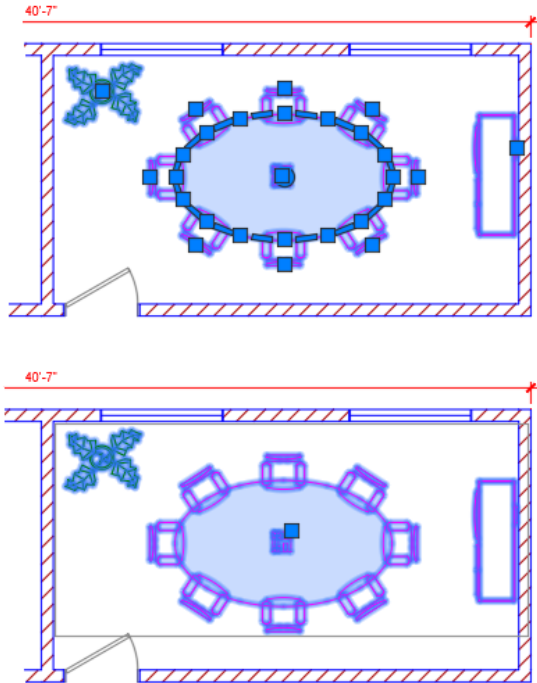

Group

Use the Group feature to perform multiple operations on the same objects without creating a block.

With the Group feature, you can quickly create temporary object associations. When objects are grouped together, selecting one object in the group results in all objects being selected, but each object can still be modified individually unlike a standard block.

1. Select the Group command from the Groups Panel in the Home tab of the Ribbon, or type GROUP into the command line
2. Select the objects that you want to associate together, and press Enter.
3. Then, when you select any object in the group, all the grouped objects are selected. A grip is displayed at the center of the group bounding box to provide access to all grip operations.
4. Add a name or description to the group for easy access later.

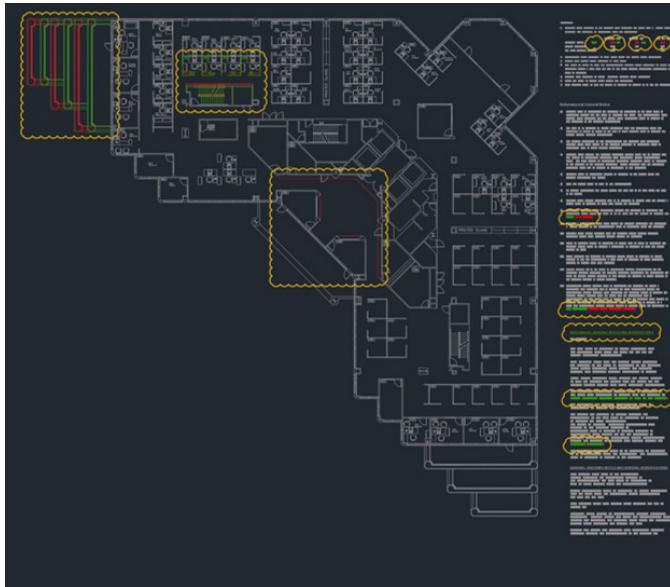

DWG Compare

Identify graphical differences between two revisions of any drawing with DWG Compare. Quickly view changes, see clashes, review constructability, and more.

There's no need to worry about missing something – turning revision clouds on will further highlight the changes, and you can systematically cycle through each one to make sure every detail is accounted for. Start a DWG Comparison in the Collaborate Tab on the Ribbon or just type COMPARE into the command line.

annotation

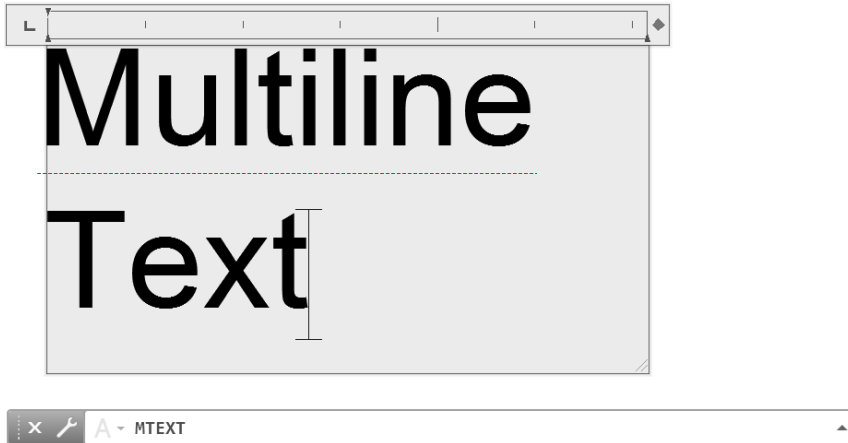

Multiline Text

Use multiline text (MTEXT) instead of single line text (TEXT) whenever possible to give you flexibility in editing your text.

You can create several paragraphs of text as a single multiline text (MTEXT) object. With the built-in editor, you can format the text appearance, columns, and boundaries.

In the Ribbon, select Annotate > Multiline Text (instead of Single Line Text) or use the MTEXT command.

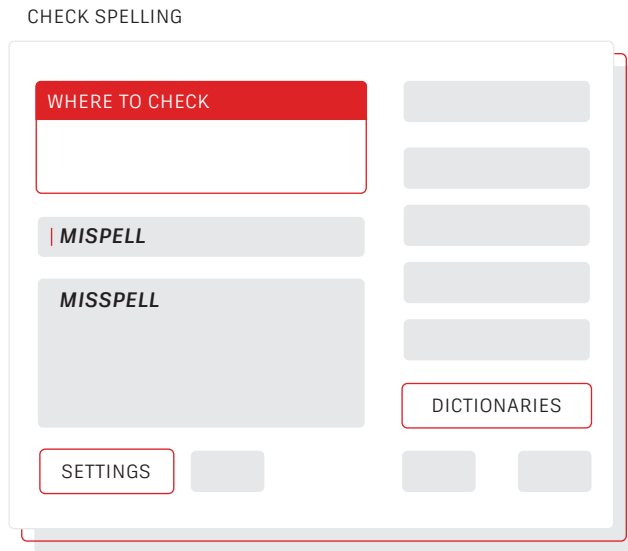

Spell Checker

Avoid embarrassing spelling errors with the spell checker (SPELL) command. There are additional options to check everything, just the current space/layout, or only selected objects.

You can find the SPELL command from the Text panel of the Annotate tab of the Ribbon (or type it in the Command Line). You'll get the Check Spelling dialog box. Click on the Settings button and you'll get further control over what's included in the check.

BONUS: One of the most powerful features here is the ability to create and update a custom dictionary. This is extremely valuable for industry-specific terms that may not be found in the standard dictionary.

FIND AND REPLACE

FIND WHAT

MISPELL

REPLACE WITH

MISSPELL

FIND WHERE

LOCATION OPTIONS

ACTIONS

SEARCH OPTIONS

TEXT TYPES

Find And Replace

Need to fix misspellings or rename certain items? Much like in your favorite word processor, you can Find and Replace words with ease in AutoCAD LT.

Start with the find text field in the Ribbon or type FIND into the Command Line. Like the spell checker, you can choose where you want to run the check. Also, there is a dialog expansion icon that will reveal additional search options and more controls on what kind of text objects are included.

BONUS: Add even more power to word search by employing wildcards. Characters such as * @ ? ~ can represent one or more characters in a text string, empowering you to get more done in less time.

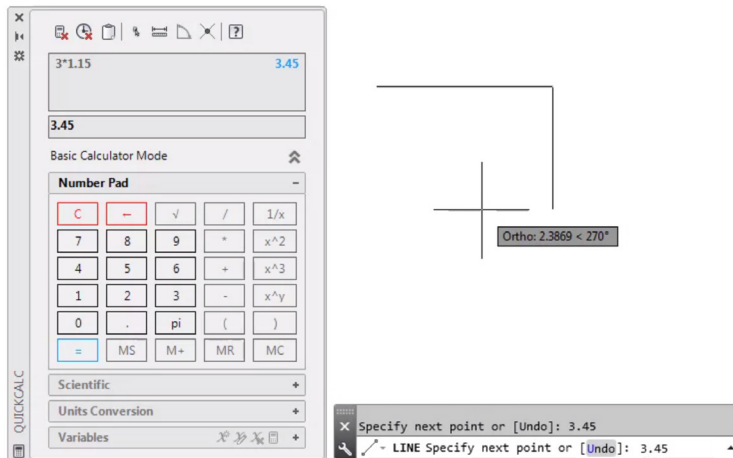

QuickCalc

Want to perform calculations right from within your drawing? The QuickCalc Calculator can be used to perform calculations within the AutoCAD LT drawing environment, and the value that's calculated can be sent directly to the current prompt for the command in progress.

In AutoCAD LT, geometric values such as distance or angular measurement are often required to draw an object. In most situations, you might know the distance or angle required to draw an object but there are times when those values are unknown and need to be calculated.

Enter QC in the Command line or click on the QuickCalc tool in the Utilities panel of the Home tab.

BONUS: Use QuickCalc during another command by right-clicking to display the shortcut menu and choosing QuickCalc. The calculator will appear without disrupting your command in progress!



**data
management**

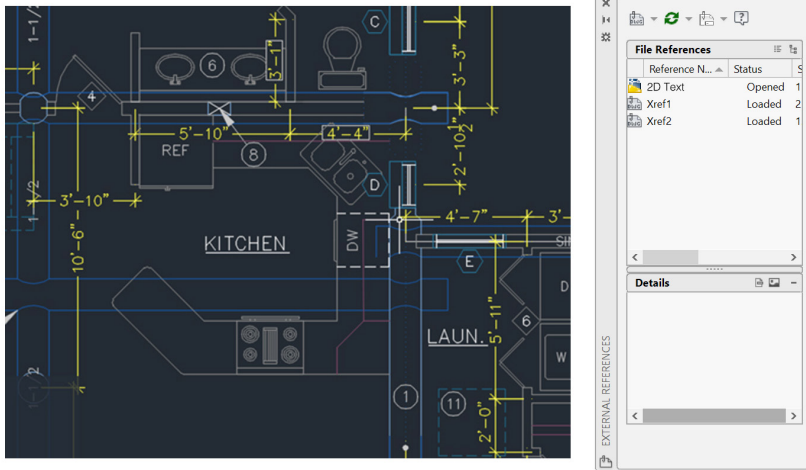

External References

Insert any drawing file as an external reference (Xref), and changes made in the referenced drawing are reflected automatically in the current drawing when opened or reloaded.

Open the External References palette by using the XREF command and select the DWG icon to attach files. Attached Xrefs are linked to, but not actually inserted in, another drawing – which avoids increasing the file size.

When you attach an Xref, the default path type is set to Relative to avoid broken Xrefs in the future. If you have relative references in the current drawing and save it to a different location, AutoCAD LT will prompt you to update the relative paths.

BONUS #1: To find an external reference in a complex drawing, select an item in the External References palette to highlight all visible instances in the drawing. Conversely, select an external reference in the drawing to highlight its name in the External References palette.

BONUS #2: Easily edit an Xref by selecting it, then Right-click and select either *Open Xref* or *Edit Xref in-Place*.

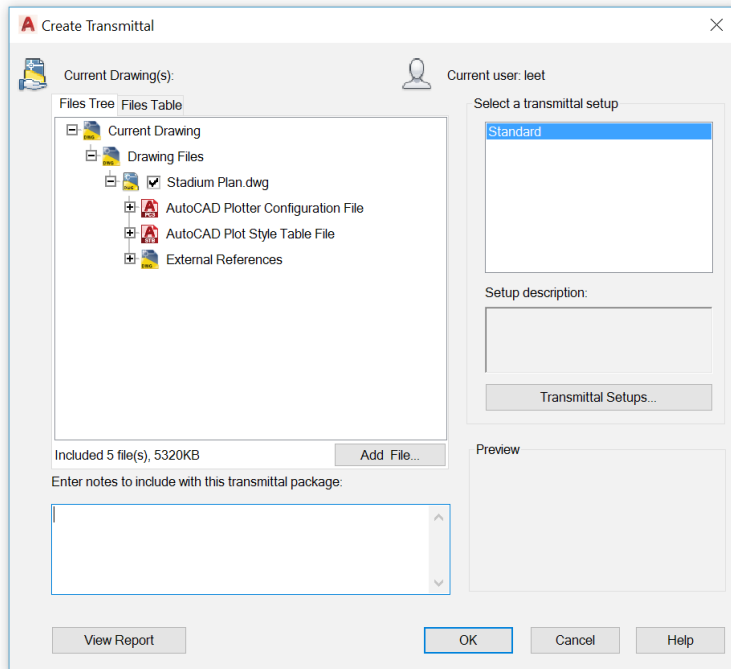

eTransmit

When sharing DWG files containing Xrefs with others, package and deliver groups of drawings and related files using eTransmit. This prevents broken links and other errors when someone else opens your files.

Xref links will be broken when you share the file with someone else, since they do not have your referenced files.

To create a transmittal package in a folder, click Application Menu > Publish > eTransmit or use the ETRANSMIT command. The Create Transmittal dialog box is displayed with options.

When you select a set of drawing files in a transmittal package, it automatically includes all related dependent files such as Xrefs and font files.

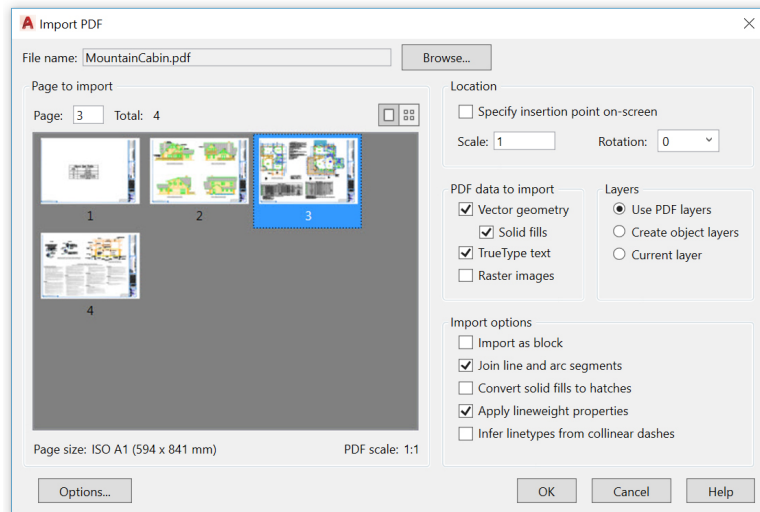

PDF Import

Import geometry, fills, raster images, and TrueType text from a PDF file into your current drawing using PDF Import.

PDF files are the most common file format used when exchanging design information between designers, contractors, clients, and others. Use the PDFIMPORT command to import geometry from a PDF page into the current drawing as AutoCAD objects. You can also access PDF Import in the Insert tab of the Ribbon, then click on Import Panel > PDF Import. After selecting a PDF file, use the Import PDF dialog box to customize your import.

BONUS: If your PDF contains AutoCAD .shx fonts, use the Recognize SHX Text tool to convert them into single line Mtext objects. You can find it in the Import panel of the Insert tab.

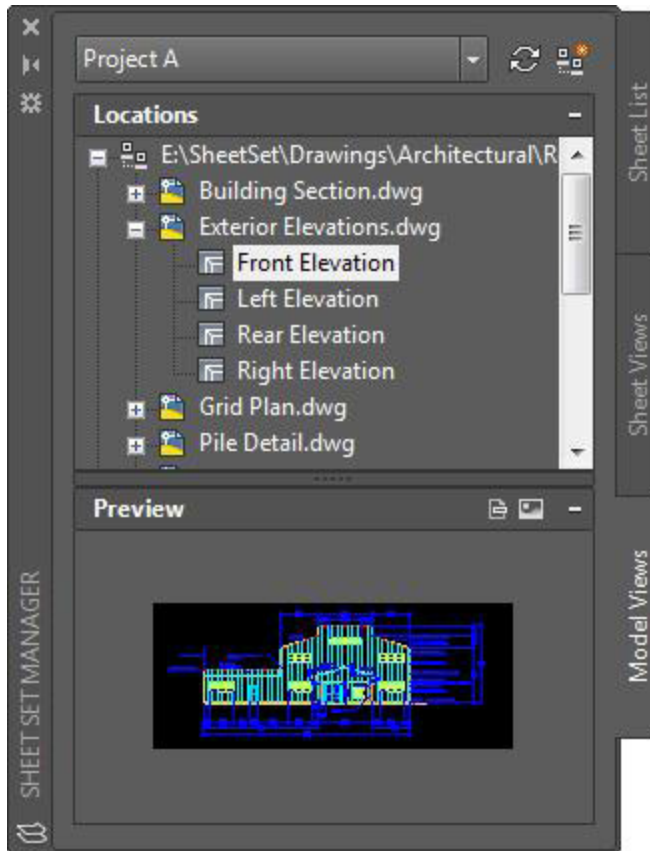

Sheet Set Manager

Keep your team on track by using the power of AutoCAD LT's Sheet Set Manager. Organize and maintain your drawing layouts, file paths, and project data from one place, accessible by your entire team.

Sheet Set Manager not only functions as a file management system for your layout sheets, but it also manages saved views in both layouts and Model Space. You can easily publish part or all of the entire set, along with defining and updating title block and callout information using Fields. Getting started is easy with the Sheet Set Wizard found in the New section of the Application Menu.

BONUS: CAD Managers and others can significantly cut down the time it takes for post-project file delivery by using eTransmit directly from the Sheet Set Manager.



ecosystem

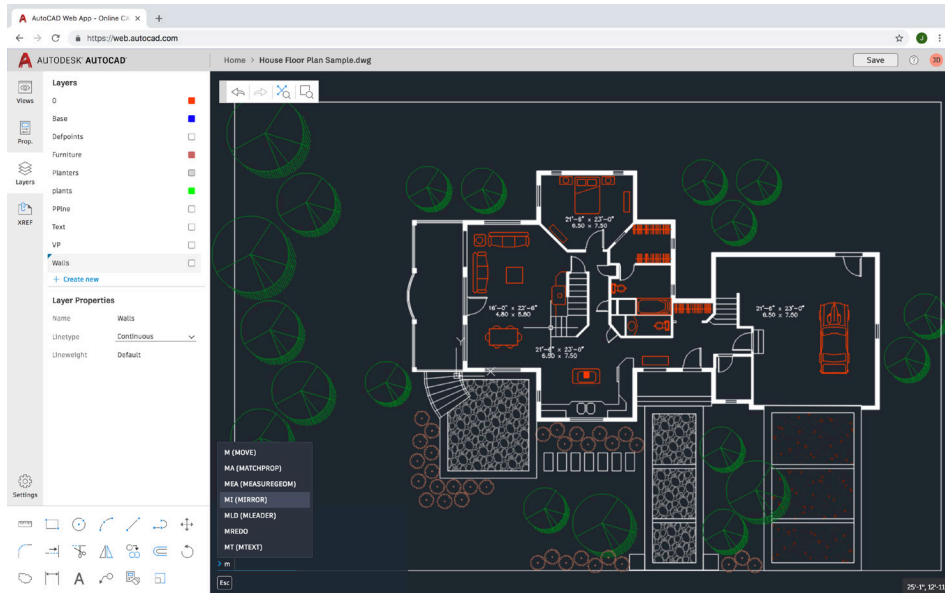

AutoCAD Web App

When you don't have access to your office workstation, the AutoCAD web app can save you in a pinch. Just go to [web.AutoCAD.com](https://web.autocad.com) using Google Chrome browser – there's nothing to download or install.

Log into the web app with your Autodesk ID (the same ID as your AutoCAD LT subscription ID). To easily save a drawing from your desktop up to the AutoCAD web or mobile apps, you can select "Save to Web & Mobile" from the AutoCAD LT desktop App Menu's Save As command. Conversely, selecting "Open From Web & Mobile" in the App Menu's Open option lets you access the latest drawings created or edited on the AutoCAD web or mobile app.

BONUS: Take advantage of a familiar AutoCAD LT desktop feature – the Command Line!

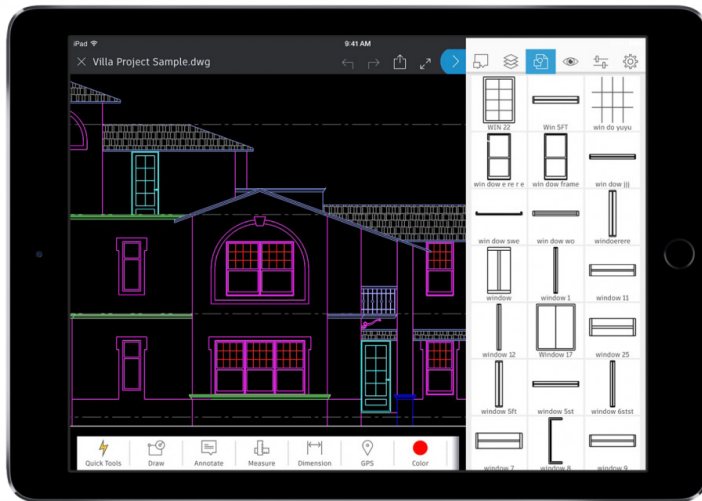

AutoCAD Mobile App

Make edits on the go and wow your clients without carrying heavy blueprints in the field. Next time you're in the field and need to access the latest drawings immediately, just reach for your mobile device to view, edit, create, and share DWGs.

Simply download the AutoCAD mobile app to your device via your device's app store. Log into the app with your Autodesk ID (the same ID as your AutoCAD LT subscription ID). Access drawings from a free Autodesk cloud storage account or other cloud accounts, including Google Drive, Dropbox, and OneDrive.

BONUS: The AutoCAD mobile app can connect directly with a Leica DISTO device. Create a line in your drawing, take a measurement with a DISTO, and the length will update automatically.



mindset

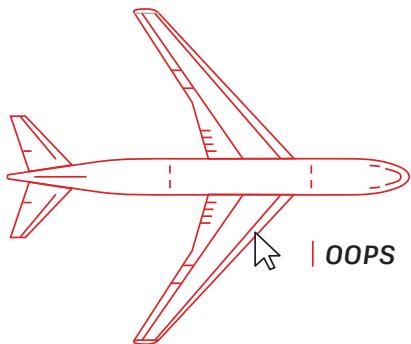
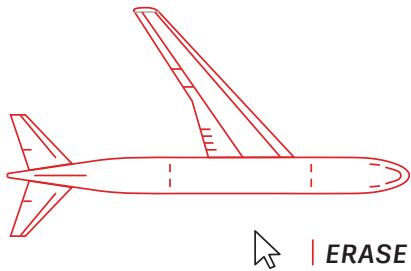
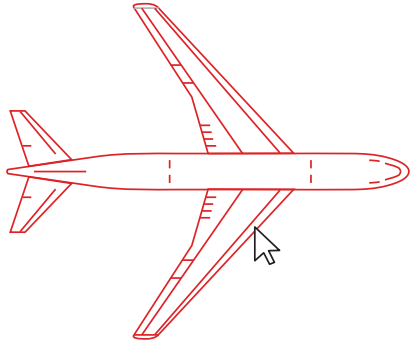

Make Mistakes

Don't be afraid to explore AutoCAD LT and make mistakes. The more mistakes you make, the better you will become at using the software.

To aid with experimentation, AutoCAD LT offers many options to correct errors:

- UNDO (or U) reverses the effect of commands. If you specify the number of preceding operations to Undo, you can avoid entering the command multiple times.
- ERASE removes selected objects from a drawing.
- OOPS restores objects erased by the last ERASE command.
- PURGE removes unused items, such as block definitions and layers, from the drawing.
- OVERKILL Removes duplicate or overlapping lines, arcs, and polylines – and combines partially overlapping or contiguous ones.

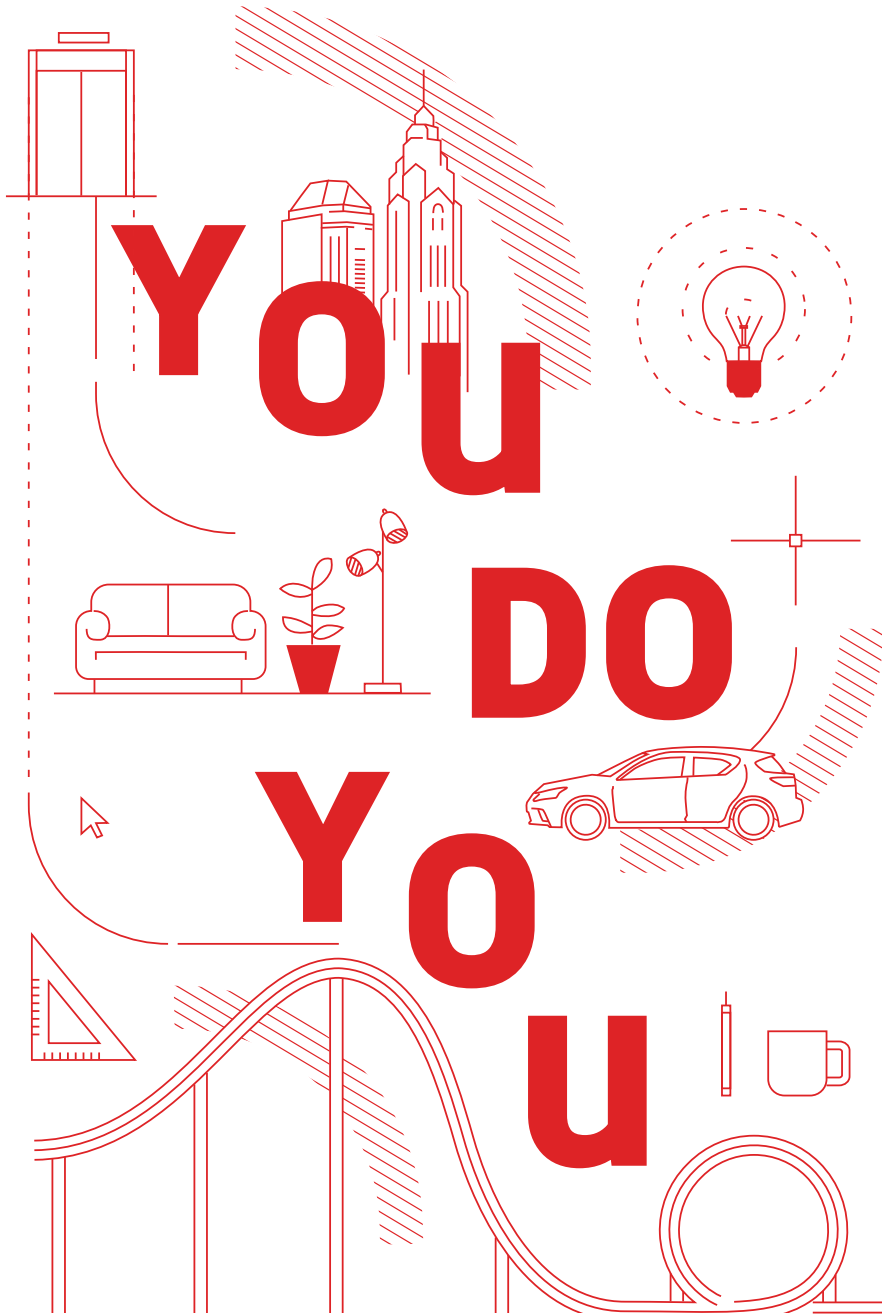

You Do You

There's no right or wrong way to use AutoCAD LT. There are likely ten or more ways to accomplish any task. While some are more efficient than others, use what is easiest for you.

We're here to help. Check out:

AutoCAD LT Website

<https://www.autodesk.com/products/autocad-lt/overview>

Autodesk Knowledge Network

knowledge.autodesk.com

AutoCAD Blog

blogs.autodesk.com/AutoCAD

This book is made possible by a number of AutoCAD users including the AutoCAD Facebook community, Frank Mayfield, Donnie Gladfelter, and many others.

Some features mentioned in this book, including DWG Compare and Save to Web and Mobile, are available starting in and AutoCAD LT 2019.

Autodesk makes software and services available on a licensed or subscription basis. Rights to install, access, or otherwise use Autodesk software and services (including free software or services) are limited to license rights and services entitlements expressly granted by Autodesk in the applicable license or service agreement and are subject to acceptance of and compliance with all terms and conditions of that agreement. When you subscribe to a plan, it may renew automatically for a fixed fee on a monthly or annual basis, subject to availability. All benefits and purchase options may not be available for all software or services in all languages and/or geographies. Access to cloud services requires an Internet connection and is subject to any geographical restrictions set forth in the Terms of Service.

Autodesk, AutoCAD LT, and the Autodesk logo are registered trademarks or trademarks of Autodesk, Inc., and/or its subsidiaries and/or affiliates in the USA and/or other countries. All other brand names, product names, or trademarks belong to their respective holders. Autodesk reserves the right to alter product and services offerings, and specifications and pricing at any time without notice, and is not responsible for typographical or graphical errors that may appear in this document. © 2018 Autodesk, Inc. All rights reserved.



AUTODESK®
AUTOCAD LT®

