

**A** AUTODESK®  
**ADVANCE STEEL**  
2019

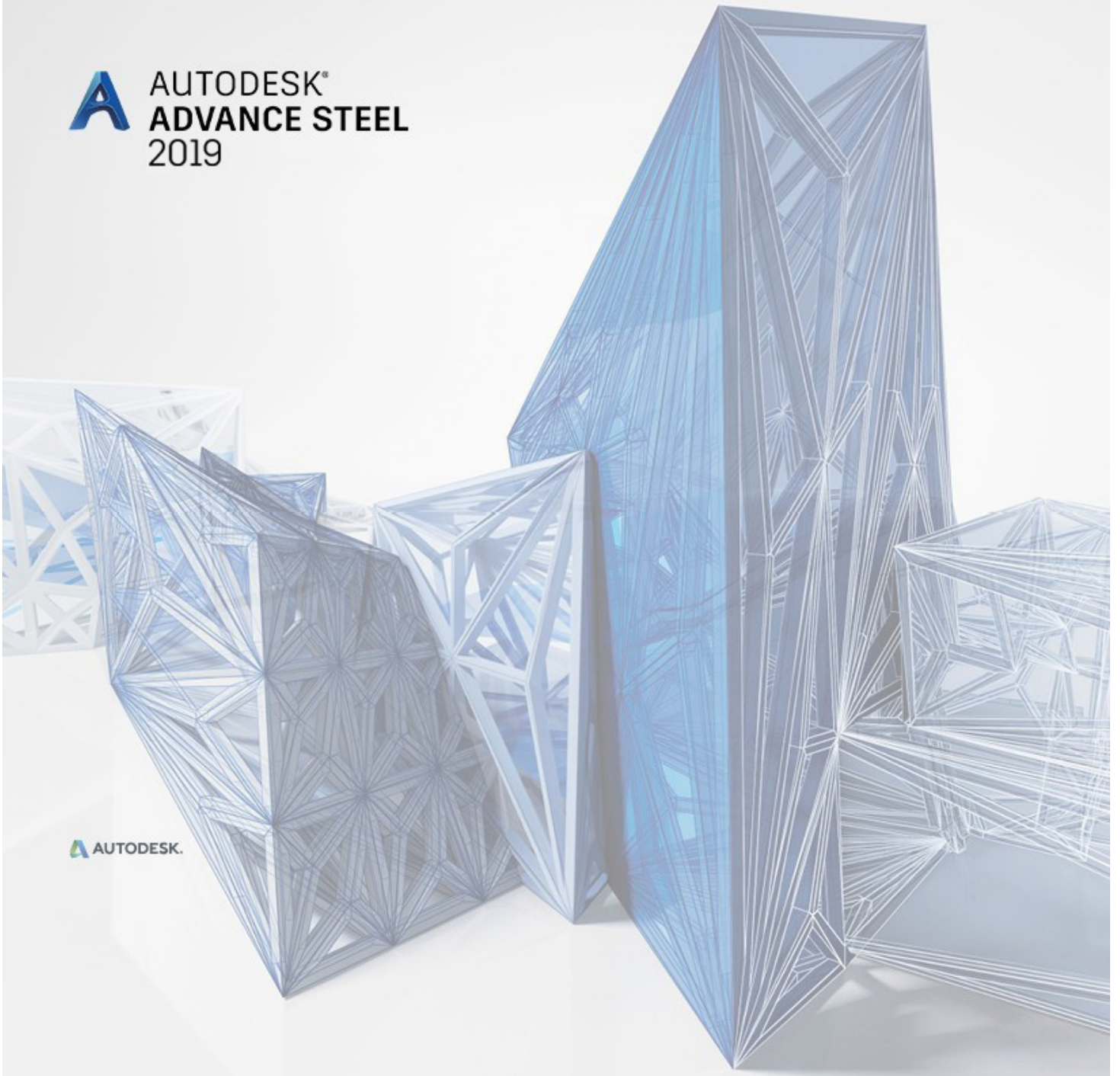

# Starting Guide

## TABLE OF CONTENTS

<b>INTRODUCTION .....</b>	<b>4</b>
Advance Steel.....	4
<b>INSTALLATION .....</b>	<b>5</b>
System requirements.....	5
Starting the installation.....	5
<b>STARTING ADVANCE STEEL.....</b>	<b>6</b>
<b>ADVANCE STEEL USER INTERFACE.....</b>	<b>6</b>
<b>1. The Quick Access Toolbar .....</b>	<b>6</b>
<b>2. The ribbon .....</b>	<b>6</b>
<b>3. Tool palettes.....</b>	<b>7</b>
<b>4. Command line.....</b>	<b>7</b>
<b>5. Status bar.....</b>	<b>7</b>
Other important tools for using Advance .....	7
Advance Steel UCS .....	7
Accessing Element Properties.....	8
<b>3D MODELING .....</b>	<b>9</b>
Advance objects .....	9
<b><i>Creating a building grid.....</i></b>	<b>9</b>
<b><i>Creating columns .....</i></b>	<b>10</b>
<b><i>Creating beams.....</i></b>	<b>12</b>
<b><i>Straight beams.....</i></b>	<b>12</b>
Automatic Steel Connections.....	14
<b><i>Accessing joint properties.....</i></b>	<b>15</b>
<b><i>Creating a Clip Angle connection.....</i></b>	<b>16</b>
<b><i>Copying a connection .....</i></b>	<b>17</b>
<b><i>Haunch connection.....</i></b>	<b>20</b>
<b><i>Connection Vault.....</i></b>	<b>20</b>
<b><i>Creating a base plate.....</i></b>	<b>21</b>
<b><i>Creating a bracing.....</i></b>	<b>23</b>

---

<b><i>Inserting a hand-railing</i></b> .....	<b>25</b>
<b><i>Inserting Straight stairs</i></b> .....	<b>26</b>
<b><i>Inserting isolated footing</i></b> .....	<b>27</b>
Clash check.....	28
<b>NUMBERING</b> .....	<b>29</b>
<b>DRAWING CREATION</b> .....	<b>30</b>
Drawing management.....	40
<b><i>Opening the Document Manager</i></b> .....	<b>40</b>
Create Shop Drawings.....	40
<b>LIST CREATION</b> .....	<b>47</b>
<b>CNC DATA CREATION</b> .....	<b>50</b>
<b>RECOMMENDED PRACTICES</b> .....	<b>51</b>
Saving the project .....	51
Modeling .....	52
Numbering .....	53
Creating drawings .....	53
Lists .....	54
NC files .....	54

## INTRODUCTION

This starting guide is a brief introduction to working with Advance Steel, describing the basic methodology and not meant to replace formal training.

Advance Steel's model based environment allows you to produce accurate detailed general arrangement and shop drawings faster, helping to speed time to erection and fabrication.

The **Advance Steel objects** chapter describes the main objects to create a small steel structure.

Some of the Advance Steel connections are described in the **Automatic Steel Connections** chapter and are used to create a small model. The 3D model is created using a 1:1 scale. The model contains information about dimensions, objects, and attributes from which drawings are created as described in the **Drawing Creation** chapter.

---

*The examples presented in this guide are generic for worldwide use and do not conform to local or specific company standards.*

---

Since not all Advance Steel tools are described in this guide, refer to the [Advance Steel Help](#) for more details on all commands and parameters.

### Advance Steel

Advance Steel is a leading edge steel construction application designed for steel professionals. It provides a simple user-friendly working environment for creating 3D structural models from which drawings are created.

The three dimensional model is created and stored in a drawing (in DWG format). The Advance Steel model forms the basis of the 3D construction. Complex structures are created using Advance Steel structural elements (e.g., a stairway) with all the required features, joints, and connections, within a command.

The Advance Steel model becomes the master reference for other tools:

- Dimensioned and labeled general arrangement and shop drawings are automatically created from the model.
- The Advance **Document Manager** manages all general arrangement and shop drawings. The update tool in the Document Manager makes single click drawing adjustments possible after model changes.
- Structured BOMs (bills of materials) and NC-information are also created from the model and include all model information such as part marks and quantities. The Document Manager also controls these documents.

MODEL DWG

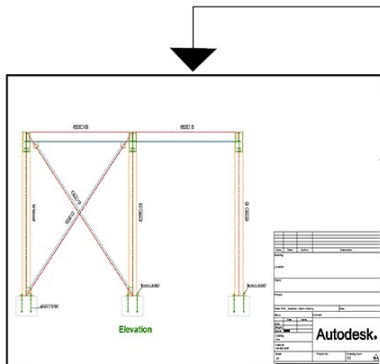
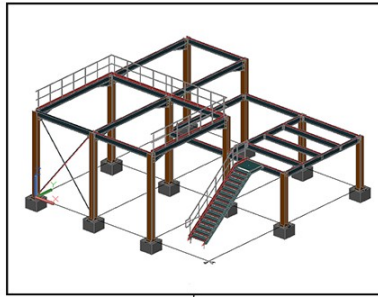

DRAWING DWG

Company: [Name] [Address] [City] [State] [Country]

Job: [Name] [Date]

Item	Quantity	Unit	Length	Width	Height	Total	Surface	Total
			(mm)	(mm)	(mm)	(mm)	(m <sup>2</sup> )	(m <sup>3</sup> )
1	4	IP200	4000	200	21	281	0.07	0.02
100	2	L100x60x10	4000	200	3	204	0.09	1.03
100	1	IP200	4000	3000	107	1000	4.1	27.02
1.000 29.42								
2	4	IP200	4000	1000	20	200	0.21	0.11
100	1	IP200	4000	2000	20	200	0.21	0.11
100	2	PL20x400x20	400	200	20	200	0.21	0.11
1.000 0.42								
3	2	HE400	4000	200	20	200	0.21	0.11
100	1	PL20x400x20	400	200	20	200	0.21	0.11
1.000 0.42								
4	2	IP200	4000	200	20	200	0.21	0.11
1.000 0.42								

STRUCTURED BOM

```

06
18
28
38
48
58
68
78
88
98
A8
B8
C8
D8
E8
F8
G8
H8
I8
J8
K8
L8
M8
N8
O8
P8
Q8
R8
S8
T8
U8
V8
W8
X8
Y8
Z8
AA
AB
AC
AD
AE
AF
AG
AH
AI
AJ
AK
AL
AM
AN
AO
AP
AQ
AR
AS
AT
AU
AV
AW
AX
AY
AZ
BA
BB
BC
BD
BE
BF
BG
BH
BI
BJ
BK
BL
BM
BN
BO
BP
BQ
BR
BS
BT
BU
BV
BW
BX
BY
BZ
CA
CB
CC
CD
CE
CF
CG
CH
CI
CJ
CK
CL
CM
CN
CO
CP
CQ
CR
CS
CT
CU
CV
CW
CX
CY
CZ
DA
DB
DC
DD
DE
DF
DG
DH
DI
DJ
DK
DL
DM
DN
DO
DP
DQ
DR
DS
DT
DU
DV
DW
DX
DY
DZ
EA
EB
EC
ED
EE
EF
EG
EH
EI
EJ
EK
EL
EM
EN
EO
EP
EQ
ER
ES
ET
EU
EV
EW
EX
EY
EZ
FA
FB
FC
FD
FE
FF
FG
FH
FI
FJ
FK
FL
FM
FN
FO
FP
FQ
FR
FS
FT
FU
FV
FW
FX
FY
FZ
GA
GB
GC
GD
GE
GF
GG
GH
GI
GJ
GK
GL
GM
GN
GO
GP
GQ
GR
GS
GT
GU
GV
GW
GX
GY
GZ
HA
HB
HC
HD
HE
HF
HG
HH
HI
HJ
HK
HL
HM
HN
HO
HP
HQ
HR
HS
HT
HU
HV
HW
HX
HY
HZ
IA
IB
IC
ID
IE
IF
IG
IH
II
IJ
IK
IL
IM
IN
IO
IP
IQ
IR
IS
IT
IU
IV
IW
IX
IY
IZ
JA
JB
JC
JD
JE
JF
JG
JH
JI
JJ
JK
JL
JM
JN
JO
JP
JQ
JR
JS
JT
JU
JV
JW
JX
JY
JZ
KA
KB
KC
KD
KE
KF
KG
KH
KI
KJ
KK
KL
KM
KN
KO
KP
KQ
KR
KS
KT
KU
KV
KW
KX
KY
KZ
LA
LB
LC
LD
LE
LF
LG
LH
LI
LJ
LK
LL
LM
LN
LO
LP
LQ
LR
LS
LT
LU
LV
LW
LX
LY
LZ
MA
MB
MC
MD
ME
MF
MG
MH
MI
MJ
MK
ML
MM
MN
MO
MP
MQ
MR
MS
MT
MU
MV
MW
MX
MY
MZ
NA
NB
NC
ND
NE
NF
NG
NH
NI
NJ
NK
NL
NM
NO
NP
NQ
NR
NS
NT
NU
NV
NW
NX
NY
NZ
OA
OB
OC
OD
OE
OF
OG
OH
OI
OJ
OK
OL
OM
ON
OO
OP
OQ
OR
OS
OT
OU
OV
OW
OX
OY
OZ
PA
PB
PC
PD
PE
PF
PG
PH
PI
PJ
PK
PL
PM
PN
PO
PP
PQ
PR
PS
PT
PU
PV
PW
PX
PY
PZ
QA
QB
QC
QD
QE
QF
QG
QH
QI
QJ
QK
QL
QM
QN
QO
QP
QQ
QR
QS
QT
QU
QV
QW
QX
QY
QZ
RA
RB
RC
RD
RE
RF
RG
RH
RI
RJ
RK
RL
RM
RN
RO
RP
RQ
RR
RS
RT
RU
RV
RW
RX
RY
RZ
SA
SB
SC
SD
SE
SF
SG
SH
SI
SJ
SK
SL
SM
SN
SO
SP
SQ
SR
SS
ST
SU
SV
SW
SX
SY
SZ
TA
TB
TC
TD
TE
TF
TG
TH
TI
TJ
TK
TL
TM
TN
TO
TP
TQ
TR
TS
TT
TU
TV
TW
TX
TY
TZ
UA
UB
UC
UD
UE
UF
UG
UH
UI
UJ
UK
UL
UM
UN
UO
UP
UQ
UR
US
UT
UU
UV
UW
UX
UY
UZ
VA
VB
VC
VD
VE
VF
VG
VH
VI
VJ
VK
VL
VM
VN
VO
VP
VQ
VR
VS
VT
VU
VV
VW
VX
VY
VZ
WA
WB
WC
WD
WE
WF
WG
WH
WI
WJ
WK
WL
WM
WN
WO
WP
WQ
WR
WS
WT
WU
WV
WW
WX
WY
WZ
XA
XB
XC
XD
XE
XF
XG
XH
XI
XJ
XK
XL
XM
XN
XO
XP
XQ
XR
XS
XT
XU
XV
XW
XX
XY
XZ
YA
YB
YC
YD
YE
YF
YG
YH
YI
YJ
YK
YL
YM
YN
YO
YP
YQ
YR
YS
YT
YU
YV
YW
YX
YY
YZ
ZA
ZB
ZC
ZD
ZE
ZF
ZG
ZH
ZI
ZJ
ZK
ZL
ZM
ZN
ZO
ZP
ZQ
ZR
ZS
ZT
ZU
ZV
ZW
ZX
ZY
ZZ

```

INTERFACES

All software tools described in this guide and all remarks related to the product pertain only to Advance Steel and for reading simplification only the generic name **Advance** is used.

## INSTALLATION

### System requirements

To successfully install Advance Steel, certain requirements have to be met.

For more details, see the [Installation help](#).

### Starting the installation

Before installing Advance Steel 2019:

- Make sure you have administrator rights.
- Close all active Windows applications.
- Disable the antivirus.

## STARTING ADVANCE STEEL

To start Advance Steel:

- Double click on the **Advance Steel** icon on the desktop.

Or

- On the Windows task bar, click , then select All programs → Autodesk → Advance Steel 2019 → Advance Steel 2019

## ADVANCE STEEL USER INTERFACE

Advance Steel is fully integrated into AutoCAD®. Advance Steel panels are added to the AutoCAD® ribbon.

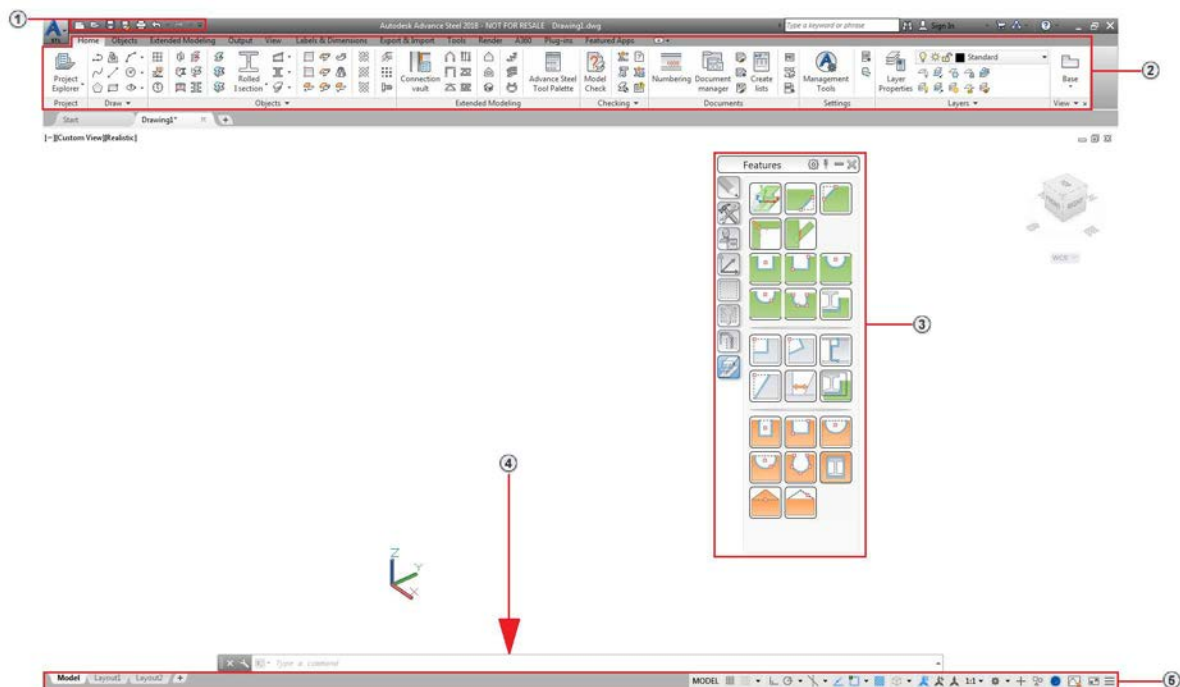

### 1. The Quick Access Toolbar

Provides fast access to the most frequently used tools. To add an Advance Steel tool to the Quick Access Toolbar, right-click the ribbon button and select Add to Quick AccessToolbar. The Quick Access Toolbar can be positioned above or below the ribbon.

### 2. The ribbon

Contains a collection of panels grouped on tabs, according to type. For easier access, the main tools are located on the **Home** tab. On the panels, tools are grouped on different rows and include large buttons for the most frequently used functionalities.

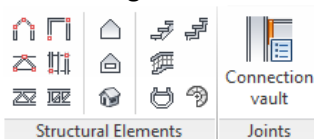

Some panels can be expanded by clicking the arrow on the bottom line.

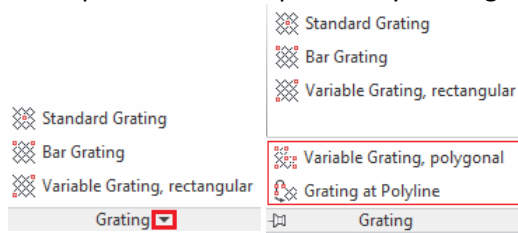

The ribbon can be minimized, thus enlarging the drawing area.

### 3. Tool palettes

Contain other tools, complementary to the functionalities available on the Advance Steel ribbon.

### 4. Command line

Allows Advance Steel commands to be entered using the keyboard. Press <Enter> after each entry.

### 5. Status bar

It displays information regarding the program status during different phases of the project. It also provides access to the configuration of certain parameters: snap modes, object tooltips content, current coordinate system, and working units.

## Other important tools for using Advance

- To cancel a command, press the **Esc** key.
- The current command and prompts are displayed in the command line window at the bottom of the screen. Press the **F2** key to open and close the command line window.
- The right mouse click behaves like the **Enter** key.
- When the cursor hovers over a ribbon button, the button's tooltip appears.
- The **Undo** command on the **Quick access** toolbar cancels one or several commands.

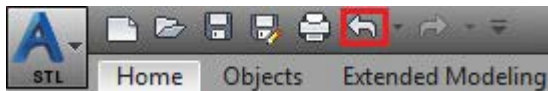

- The **Match properties** command copies properties from one object to another. The transferred properties are selected from the given list.

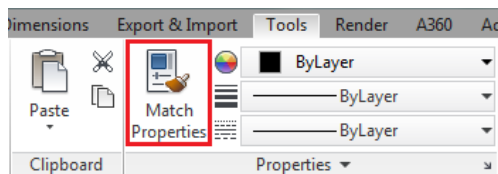

## Advance Steel UCS

Advance Steel objects are created in 3D-space using the appropriate tools and their orientation is dependent on the current User Coordinate System (UCS). To place the coordinate systems in the correct position use the Advance Steel UCS tool palette.

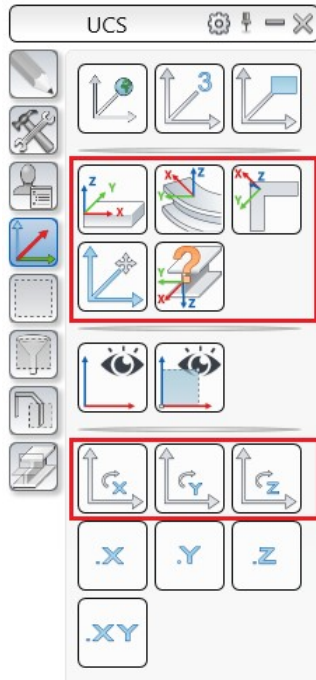

## Accessing Element Properties

When you create an Advance Steel element, a dialog appears, in which different settings and drawing styles can be changed.

There are several ways to access the element properties:

- On the Tools tool palette, click 
- Right-click the element and select **Advance Properties** from the context menu.
- Double click the element.



## 3D MODELING

### Advance objects

Advance objects are created in 3D-space using various program tools. The object's orientation depends on the current UCS (**U**ser **C**oordinate **S**ystem).

#### Creating a building grid

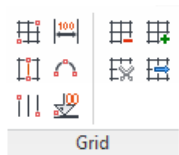

The grid is useful for placing construction elements and for orientation in the 3D view. Placing grid axes is the first step of 3D modeling in Advance.

A building grid is created in the X/Y-plane of the current coordinate system and consists of two independent axis groups: in the X- and Y- directions. The grid axis tools are grouped on the **Grid** panel of the **Objects** tab.

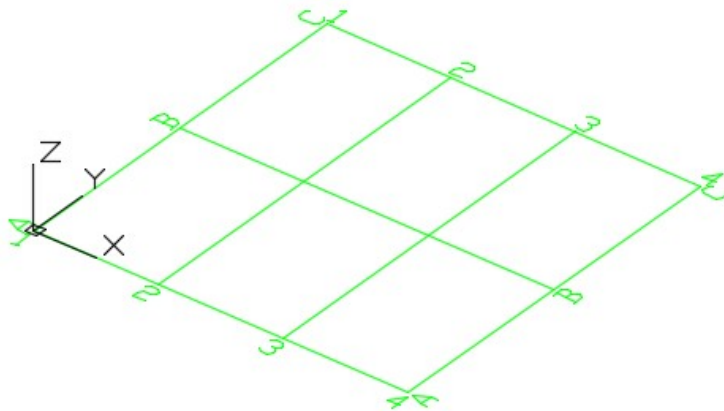

**Example:** Building grid with 4 axes in the X-direction and 3 axes in the Y-direction:



1. On the ribbon, click  (Building Grid).
  - Home → Objects →  (Building grid)
  - Objects → Grid →  (Building grid)
2. Enter 0, 0, 0 on the command line to set the first point in the origin.
3. Enter 12000, 12000 to set the second point.

Next, modify the axes number in each group.

1. Select the X-axis group.
2. Right click and select **Advance Properties** from the context menu. The *Axes parallel* dialog box appears. All modifications are made here.

To modify the number of axes:

1. Click the **Group** tab.
2. Set the **Number** to **3**. Note that the distance value is automatically calculated. The new value in the **Distance** definition should be **6000**.

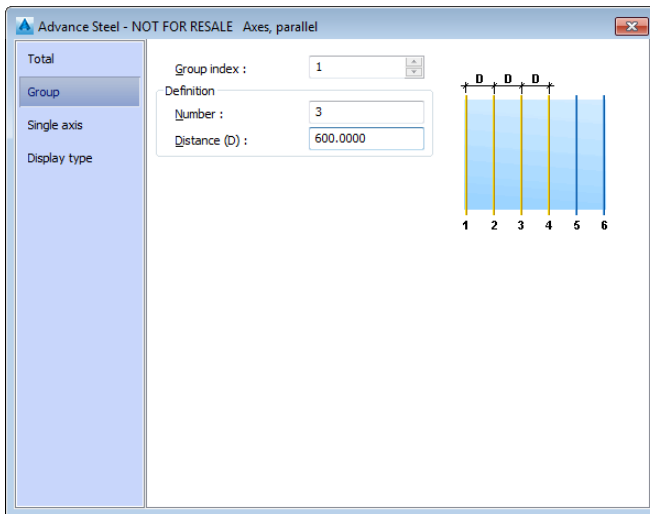

The model changes dynamically as values are entered or new values are selected, providing instant visual feedback.

Repeat the same steps for the axes in the Y-direction, but setting the **Number** definition in the **Group** tab to 4.

### Creating columns

Columns are created directly in the model and are displayed, by default, in the *Wireframe* mode.

Columns are created as simple sections, compound sections, curved sections or welded sections. The column creation is performed using the **Column** command on the **Beams** panel, **Objects** tab.

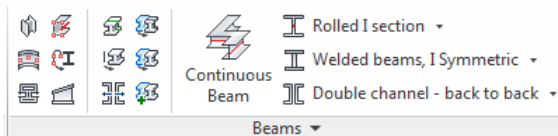



The command can also be found in the **Objects** panel, on the **Home** tab.

Columns are simply placed in the model. You can place as many columns as you need. To exit the command press the **Esc** or **Enter** keys or right-click your mouse.

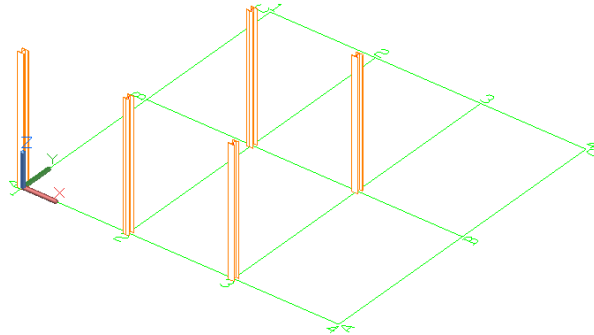
**Example:** *Creating HEA240 columns.*



1. On the ribbon, select 
  - Home → Objects → 
  - Objects → Beams → 
2. Place the columns where you need in the model. In this example they are placed at the grid intersections.

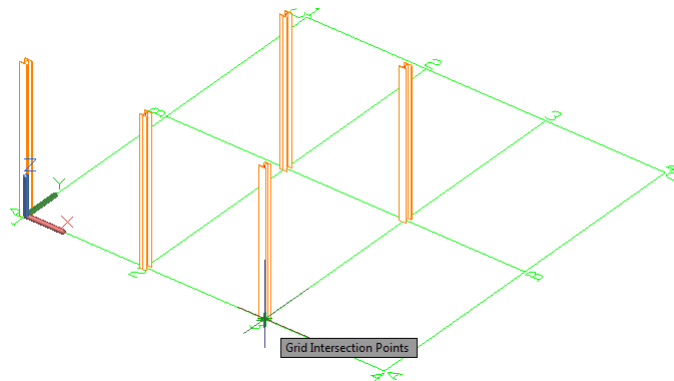

3. Right-click your mouse to exit the command.

The *Beam* dialog box appears. Select the section class (HEA DIN 1025-3), followed by the section (HEA240).

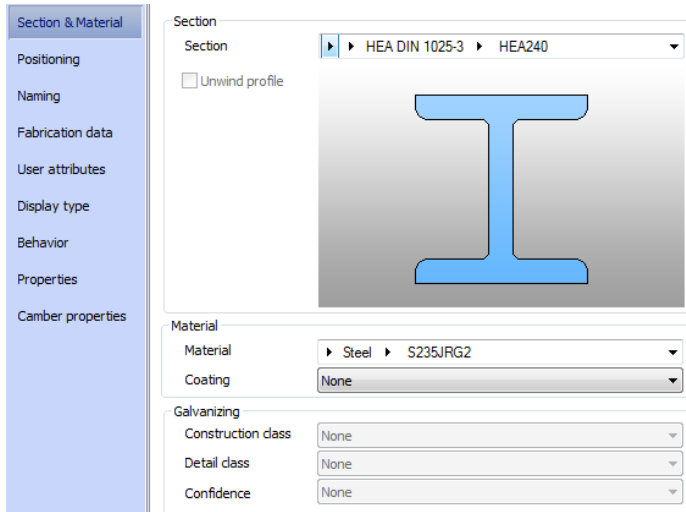

### Creating beams

Beams are created directly in the model and are displayed, by default, in the *Wireframe* mode.

In Advance, a variety of different beam types are available. Beams are created as simple sections, compound sections, curved sections or welded sections. The beam creation is performed using the tools on the **Beams** panel, **Objects** tab.

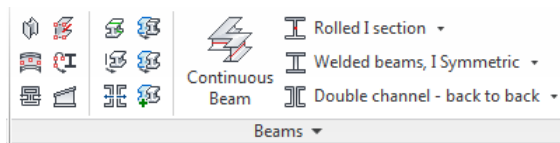



The most used beam creation tools are grouped on the **Objects** panel, on the **Home** tab.

### Straight beams

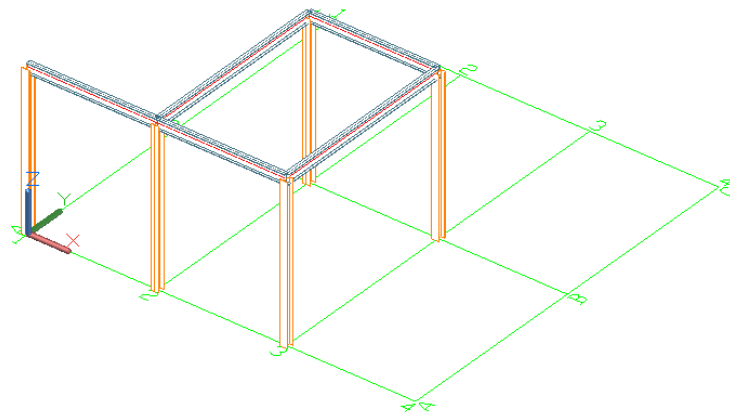
**Example:** Creating IPE300 straight beams from the top of one column to another.



1. On the ribbon, select .
  - Home → Objects → 
  - Objects → Beams → 
2. Select a *Node* snap point on the top of the first column.

**Note:** Make sure the *Node* option is checked in the *Object Snap* menu.

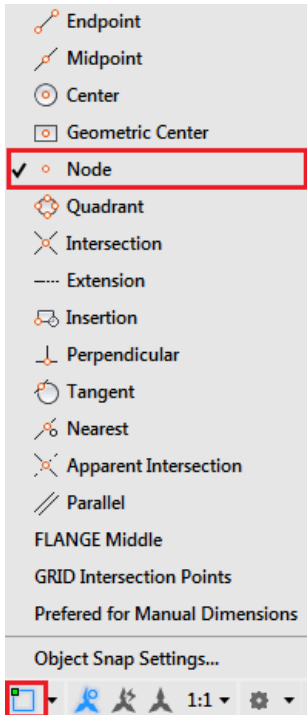

3. Move the mouse pointer to the second column top.

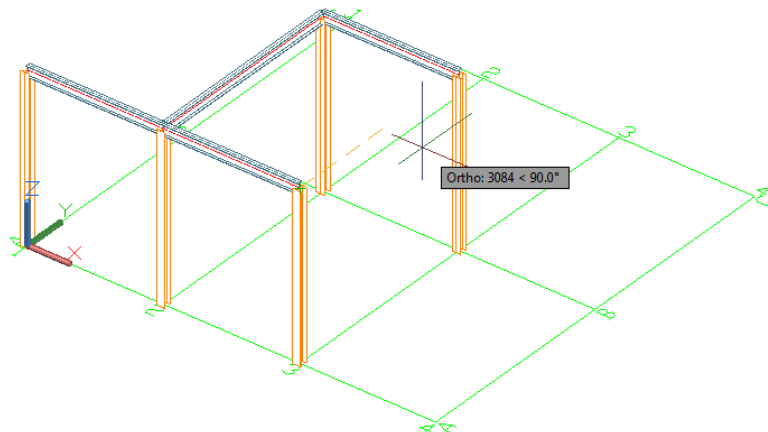

4. Repeat the same steps for as many beams as you want to create and then press **Enter** to exit the command.

**Note:** For a continuous beam creation, use the **Continuous Beam** command from the **Objects** tab, **Beams** panel. Unlike the other beam creation commands, this one lets you select points continuously, not only creating objects defined by two points, one by one.

The Beam dialog box appears. Select the section class (IPE DIN 1025-5), followed by the section (IPE300).

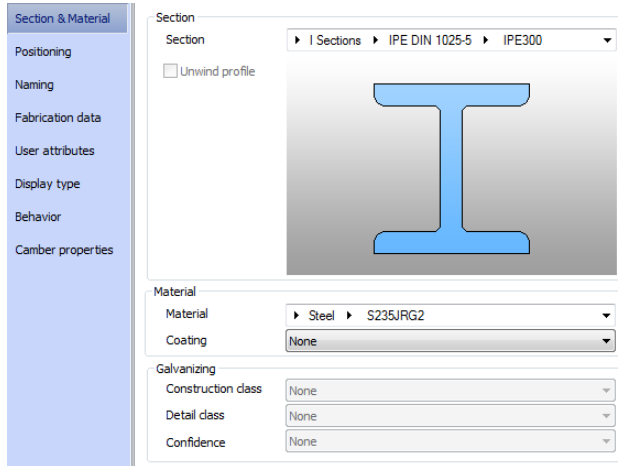

### Automatic Steel Connections

Advance Steel helps you improve productivity by providing a parametric library of steel connections.

All individual joint elements, including their properties, are held together and represented as a gray box connection object.

**Note:** A structural element creates several Advance objects at a time (i.e., entire structures are created by simply clicking one button).

All parts of a structural element are related to each other and their height, position, section, etc., are changed in one step.

Joints are available in the  **Connection Vault**, which is accessible from the **Extended Modeling** panel of the **Home** tab. The joints are grouped in categories according to the type of individual members.

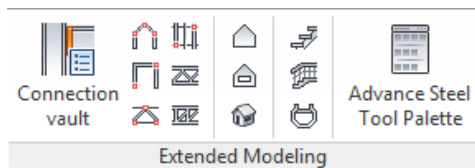

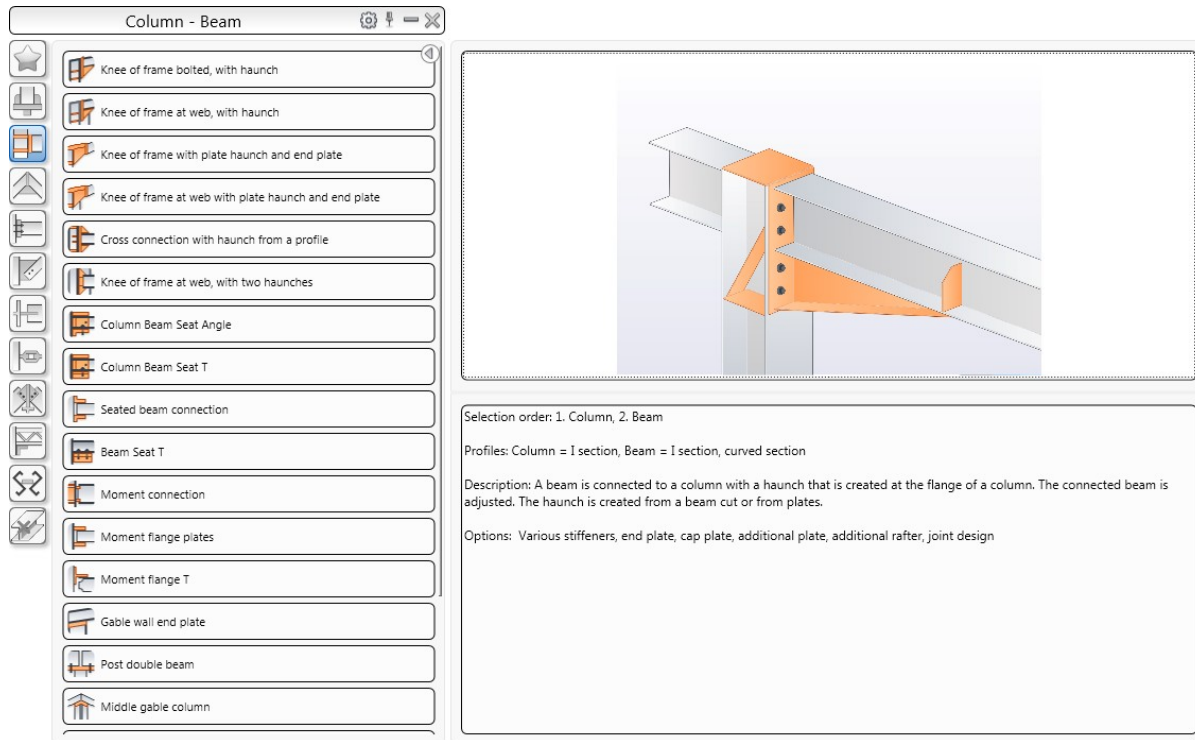

Frequently used joints can be grouped in the **Favorites** category for quicker access.

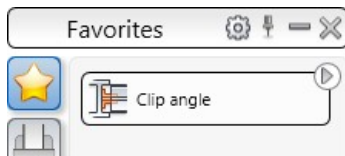

### Accessing joint properties

To access the joint properties dialog:

- Double click on the connection object (the gray box).
- Select a joint element, right-click and Select Advance Joint Properties from the context menu.

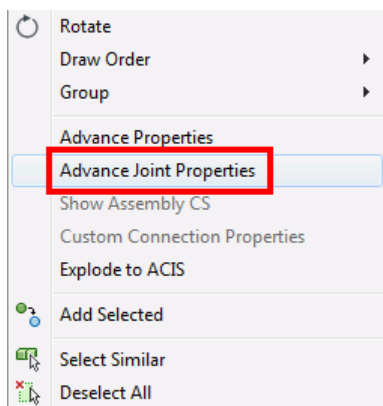



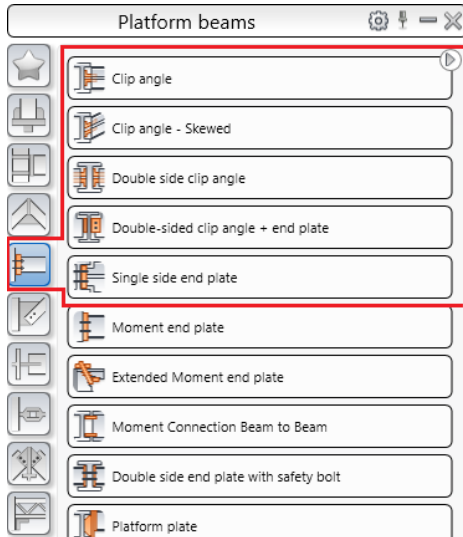

## Creating a Clip Angle connection

The clip angle connects a beam to a column using an angle profile.

The tools for clip angle connections are grouped in the **Column - Beam** category of the **Connection Vault**.



**Example:** *Creating a clip angle connection.*

1. On the ribbon, click  (Connection Vault).
  - Home → Extended Modeling →  (Connection Vault)
  - Extended Modeling → Joints →  (Connection Vault)
2. From the **Platform Beams** category, click  Clip angle
3. Select the column and right click.
4. Select the beam on which the clip angle should be created and right click.

The joint is created and the properties dialog appears. Modify the joint properties to suit specific requirements.



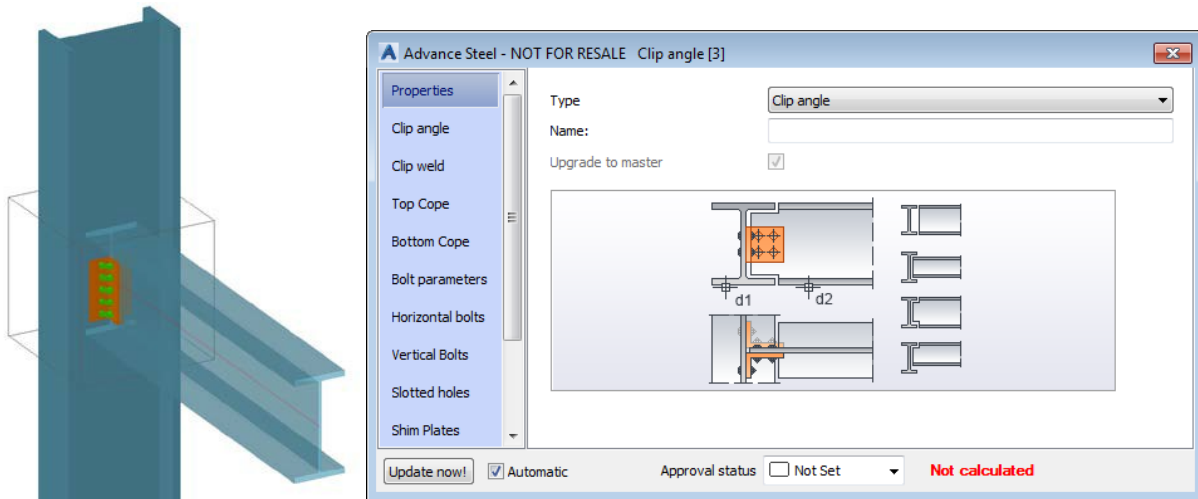

## Copying a connection

Any previously created joint can be used as a template and copied with all its properties.

**Example:** Copying a clip angle.

1. Select any object created by the clip angle connection to be used as a template.
2. On the **Tools** tool palette, click  (Create by template).
3. Select the destination column and right click.
4. Select the corresponding rafter.

When a joint is copied, all its properties and logic relations are copied and the values for the joint are only entered once.

## Zoom/Shade

To better view the created connection, use the **Zoom window** tool.

---

**Note:** You can find this tool in the Navigation Bar on the right side of your workspace. If the Navigation Bar is closed, you can open it, by going to the **View** tab → **Viewport Tools** panel and clicking on the **Navigation Bar** button.

---

For a more realistic presentation of the model, use a shaded visual style. From the menus on the top-left corner of the drawing area select **Realistic**.

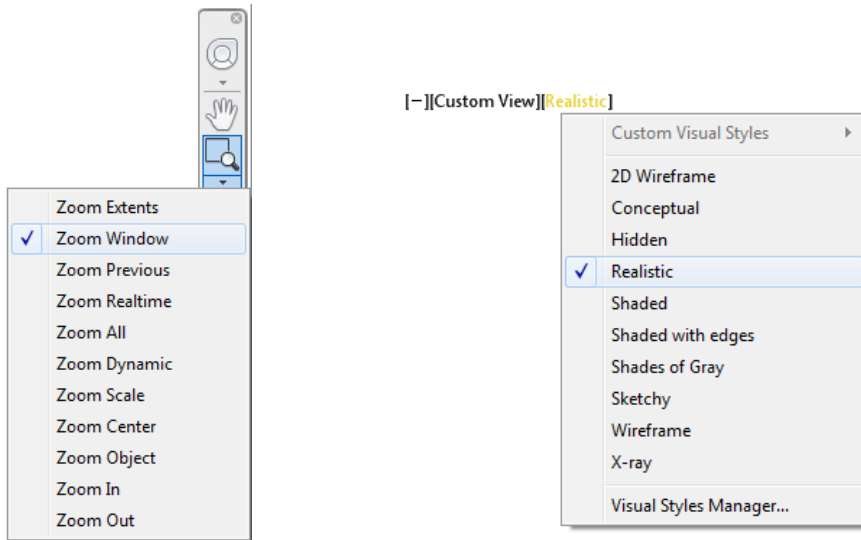

To cancel the shading, return to the **2D Wireframe** visual style.

**Note:** For a cleaner **Realistic** look, set the Visual Style to not show the *Occluded Edges*.

To do this:

1. Open the **Visual Styles Manager**, from the **View** tab.

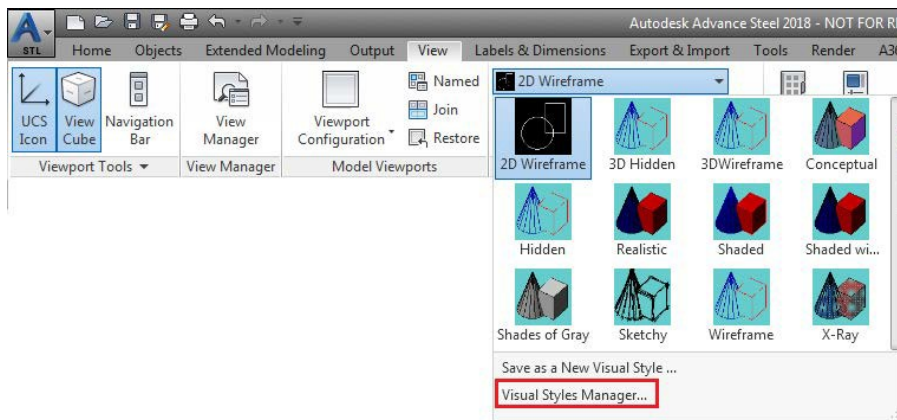

2. Select the **Realistic** visual style.
3. In the settings box, go to **Occluded Edges** and make sure that the *Show* setting is set to **No**.

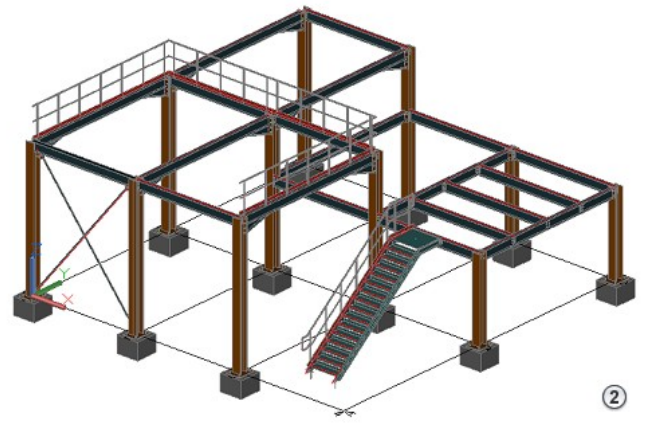
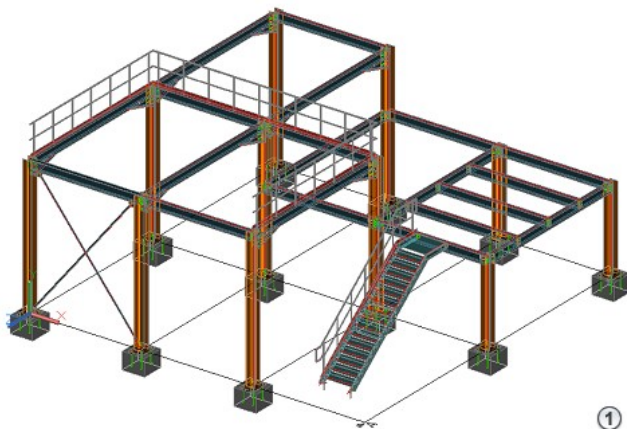
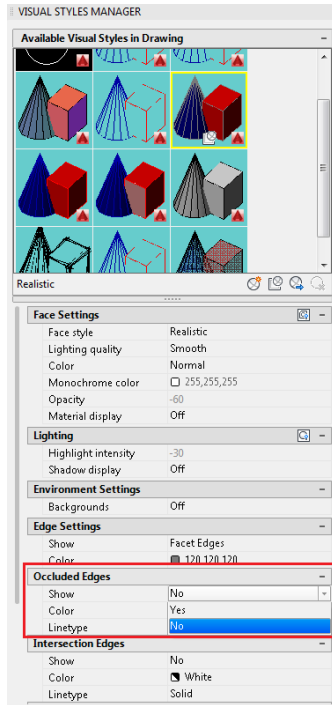

- ① - Occluded Edges on.
- ② - Occluded Edges off.

### Cancel Zoom

To view the whole object, use the **Zoom Extents** tool. The entire frame is displayed.

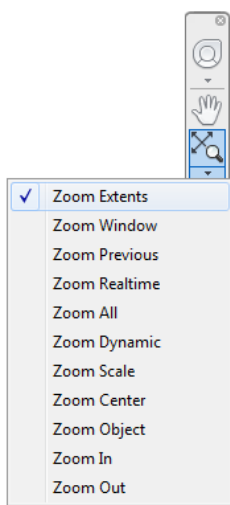

### Haunch connection

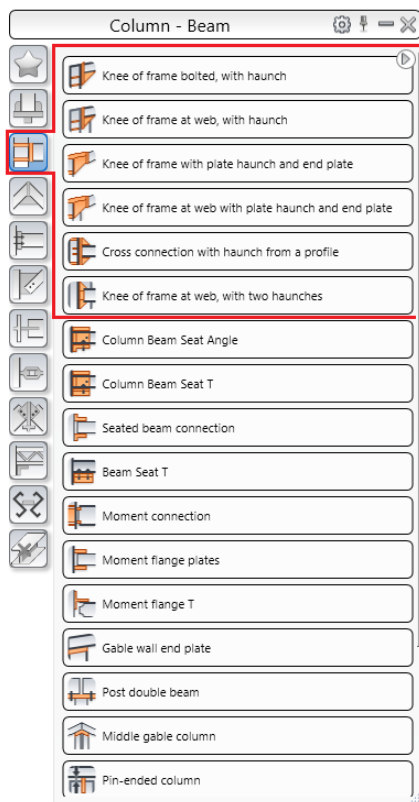

The haunch connects a column and a beam, using an end plate, welded to the beam and bolted to the column.

The tools for creating haunch connections are grouped in the **Column - Beam** category of the **Connection Vault**.



**Example:** Creating a haunch connection.

Go to the beams you need to connect.

1. On the **Home** tab, **Extended Modeling** panel, click 
2. From the **Column - Beam** category, select  Knee of frame bolted, with haunch
3. Select the column and right click.
4. Select the beam and right click.

The connection is created and can be modified in the properties dialog box.

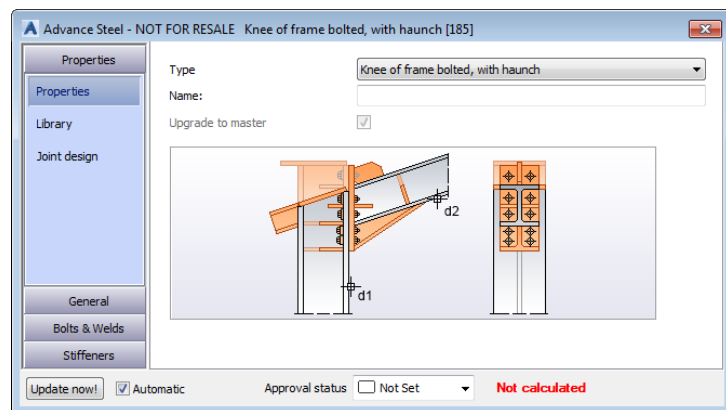
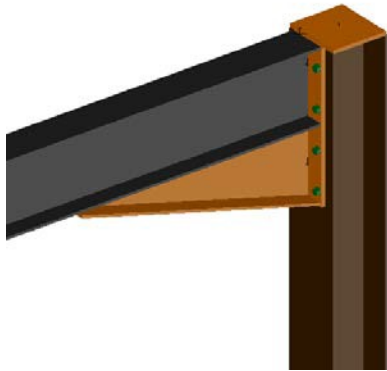



### Creating a base plate

In this example, a base plate is created at the bottom of a column. The column is automatically shortened by the thickness of the base plate.

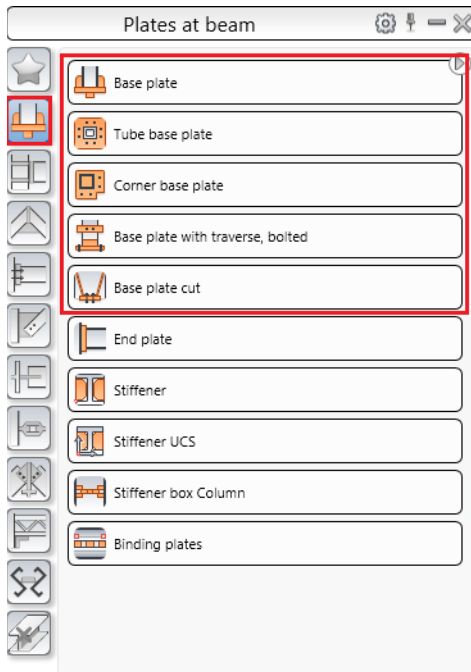
The tools for base plate connections are grouped in the **Plates at beam** category of the **Connection Vault**.



**Example:** Creating a base plate.

1. On the **Home** tab, **Extended Modeling** panel, click 
2. From the **Plates at beam** category, select  Base plate
3. Select the column and right click.

The base plate is created at the end of the column and can be modified in the properties dialog box. Both the column and the plate are welded together.

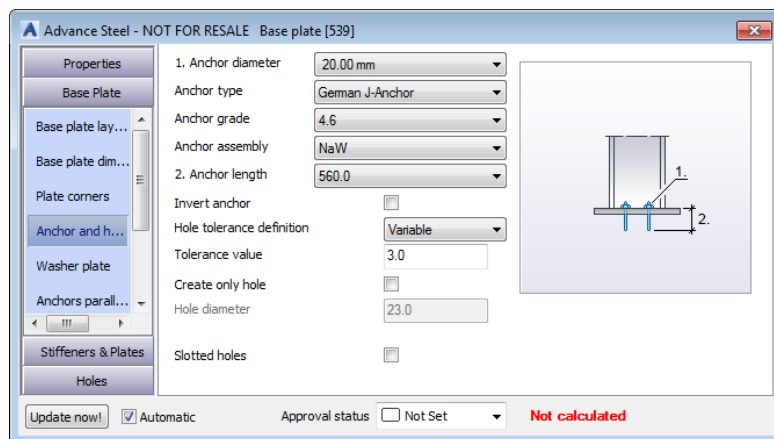
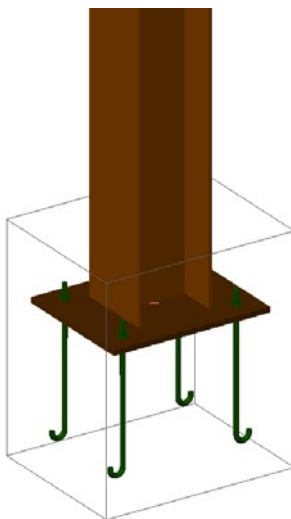

### Creating a bracing

You can create a bracing, using the Bracing command on the ribbon.

To access the Bracing command:

1. Go to the **Extended Modeling** tab → **Structural Elements** panel and click (Bracing).

**Note:** Bracing creation is UCS dependent so make sure you set your UCS accordingly. Use the Move UCS tool, from the Advance Steel Tools Palette → UCS category and set the UCS accordingly, to create the view in the XY plane.

To set the UCS on the correct plane, use the UCS tools in the Advance Steel Tool Palette, UCS category:

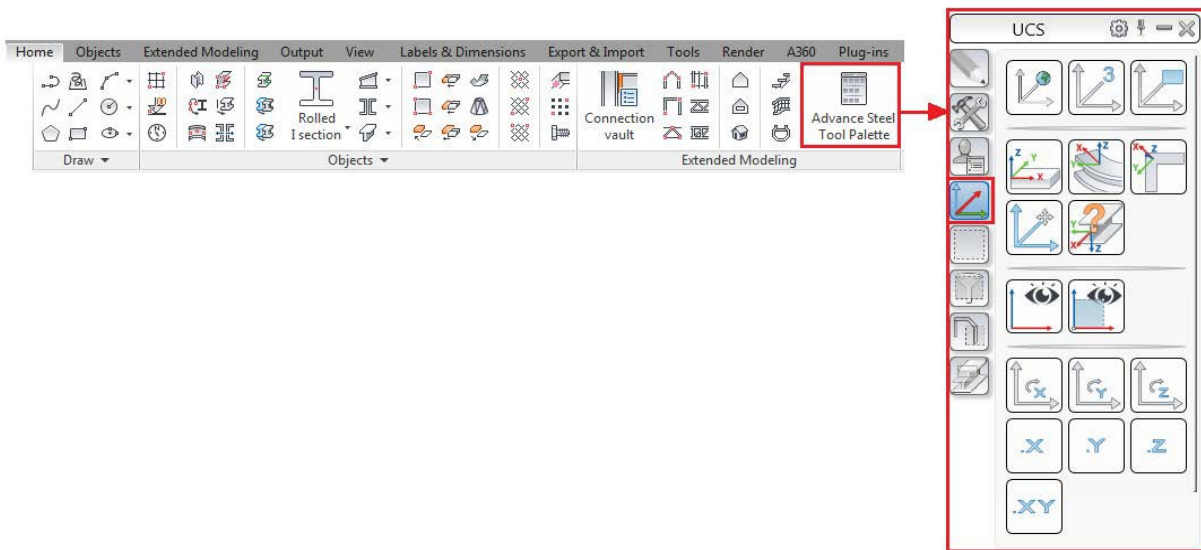

2. Create your bracing in the XY plane by selecting two diagonal points on the two columns.

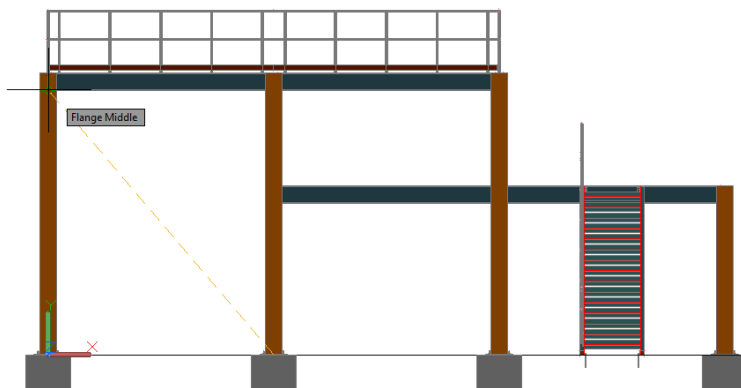

- The bracing is placed and the properties dialog box appears, where you can make any required modifications to your bracing.

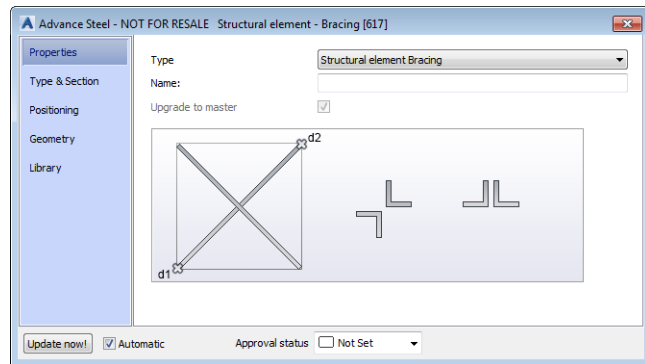
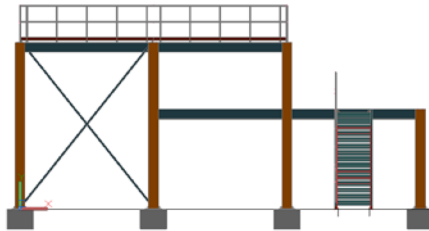

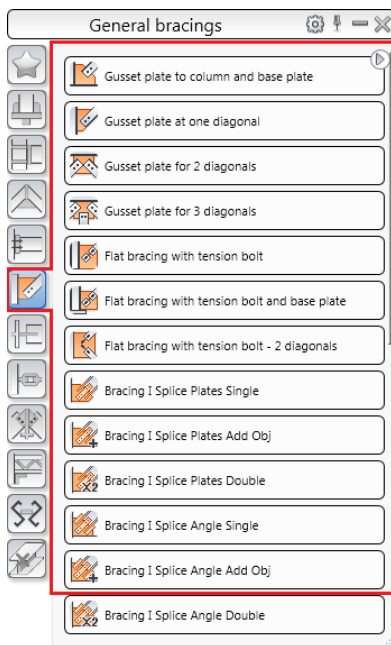

Now you're ready to connect the bracing to the columns.

In this example, gusset plates at one diagonal will be created. The tools for connecting bracing members using gusset plates are grouped in the **General bracing** category of the **Connection Vault**.



**Example:** Creating a Gusset plate at one diagonal connection.

- On the **Home** tab, **Extended Modeling** panel, click 
- From the **General bracings** category, select  Gusset plate at one diagonal
- Select the **column** to connect and right-click.
- Select the **bracing beam** to connect and right-click.



The connection is created and can be modified in the dialog box.

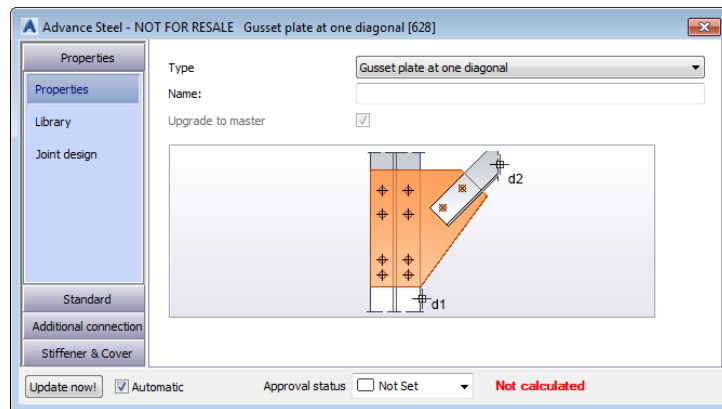
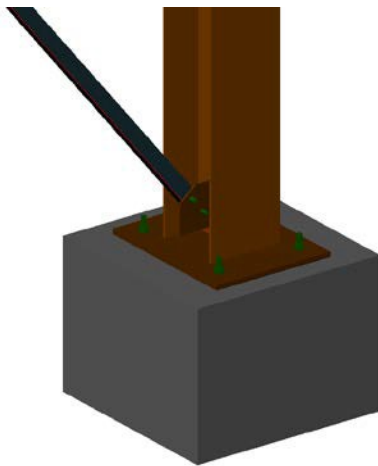

Repeat the steps for the other 3 connections.

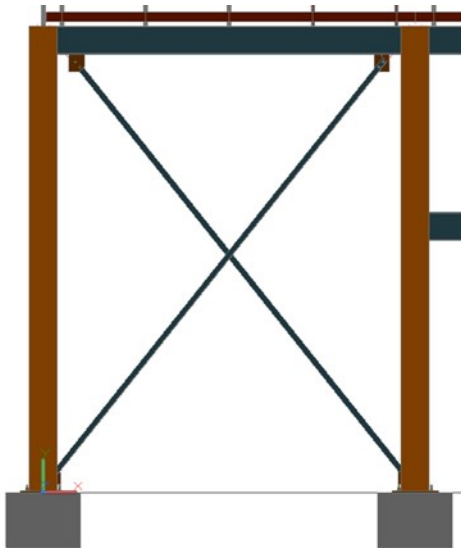

### Inserting a hand-railing

The Hand-railing command on the ribbon easily creates a hand-railing along a beam, between selected points. Simply select the beam and the points between which you want the railing to run and the hand-railing is automatically created.

**Example:** *Creating a hand-railing on a selected beam.*

1. On the **Home** tab, **Extended Modeling** panel or on the **Extended Modeling** tab, **Structural Elements** panel, click  (Hand-railing).
2. Select the beam and right click.
3. Select a start point and an endpoint for the railing and right click.

A message will appear, asking you if you want to select a nosing point relative to the start point.

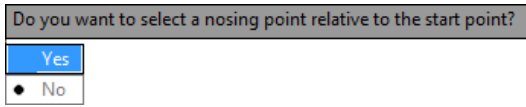

4. Select Yes or No:
  - If you select No, the railing is automatically created and the properties dialog appears.
  - If you select Yes, after you select the nosing point, the railing is automatically created and the properties dialog appears.
5. Make the necessary settings in the dialog box.

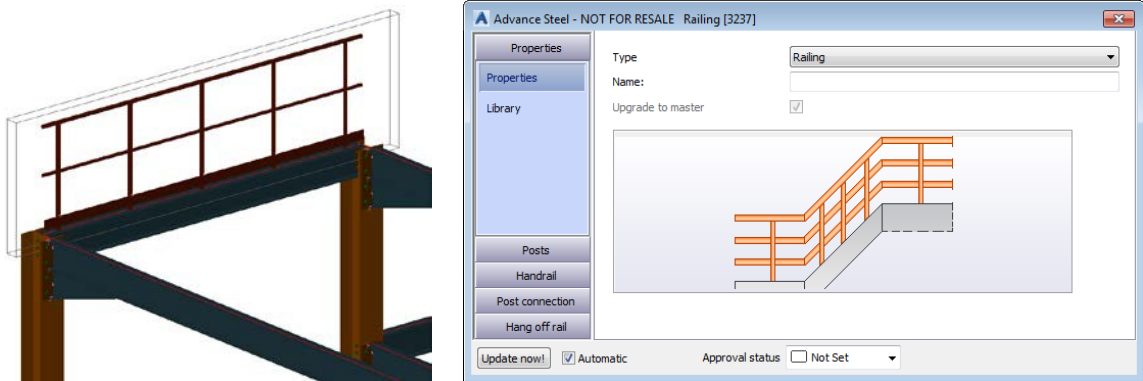

### Inserting Straight stairs

You can easily create stairs; by using the stair creation commands (straight, spiral stairs or cage ladders) on the ribbon.

**Example:** *Creating a straight stair between two points.*

1. On the **Home** tab, **Extended Modeling** panel or on the **Extended Modeling** tab, **Structural Elements** panel, click (Straight stair).
2. You will have three methods to define the stair size: *Start and end point*, *Length and angle* or *Height and angle*. Choose the default *Start and end point* method by pressing **Enter**.

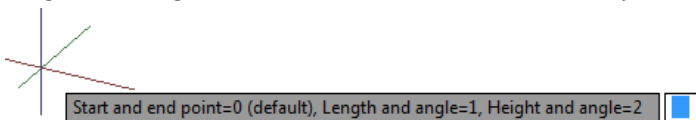

3. Select the start and end point of the stairs.

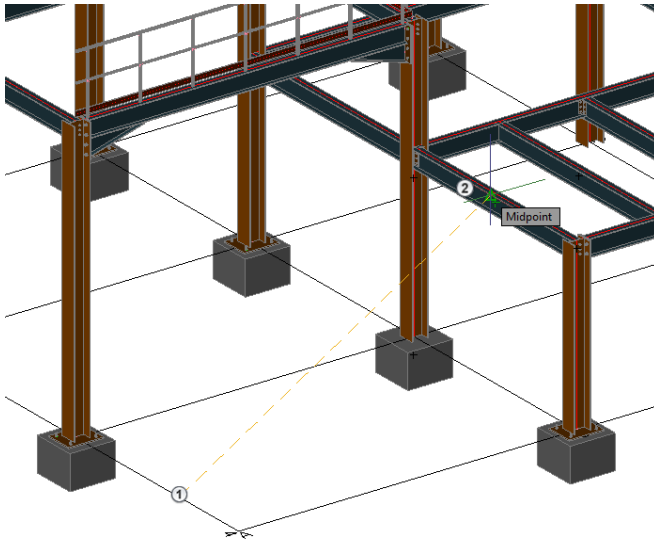

4. Choose the stair alignment (left, middle, right).

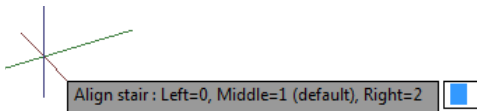

5. The stair is created and properties dialog box appears, where you can make the necessary settings.

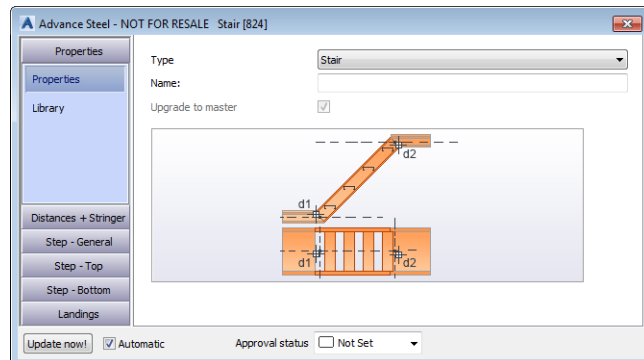
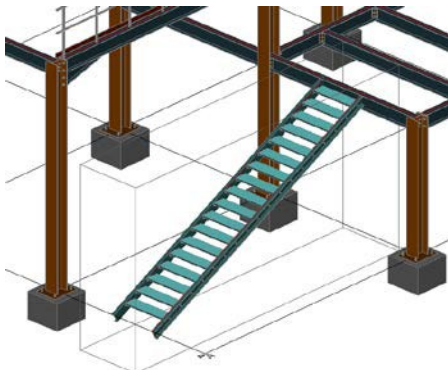

### Inserting isolated footing

**Example:** Creating an isolated footing under a column base plate.

To insert an isolated footing:

1. Go to the **Objects** tab → **Other objects** panel and click  (Isolated footing).
2. Specify the position of the footing or select a snap point to define its position under the base plate.

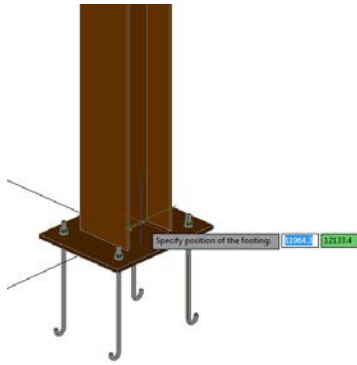

3. The isolated footing is created and the properties dialog box appears, where you can make the necessary settings.

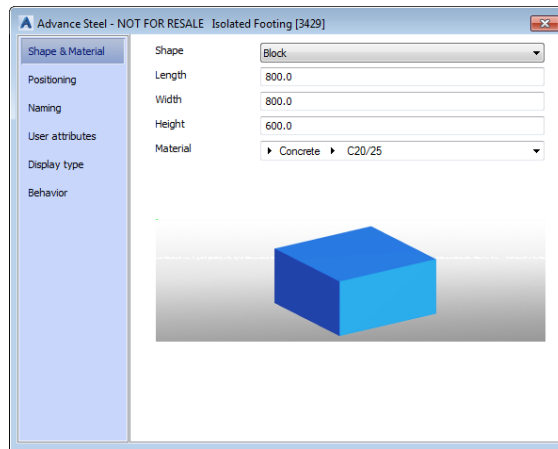
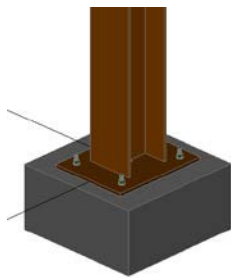

### Clash check

A clash check tests if there are model interferences. Object interferences might be due to various modifications made to plates, bolts, members and their connections. This tool finds all interference cases so that they are fixed in the model before drawing creation.

The Advance **Clash Check** function checks selected elements or the entire model. Interferences are displayed as red collision solids and listed in a text window.

**Example:** Checking the created frame for interferences

1. On the **Home** tab → **Checking** panel, click  (Clash check).

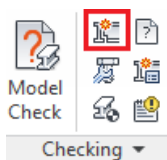

The Clash check dialog box appears containing the list of all collisions. If there are no collisions, the notification line displays “Collision check found no errors.”

2. Close the window.

## NUMBERING

The Advance numbering tool **automatically** numbers Single Parts and Assemblies for the entire model. The numbering finds **identical parts** that should have the same number.

The numbering procedure is a single button function and works on the entire model or on selected elements.

With automatic numbering all beams and plates obtain a single part mark. All other elements are classified as attached parts. The numbering for single parts and assembly parts is done in one step or separately. The numbering tools are grouped on the **Part marks** panel of the **Output** tab.



**Example:** Numbering single parts and assemblies in one step.

1. On the ribbon, click (Numbering).
  - Home tab → Documents panel, click
  - Output tab → Part marks panel, click
2. In the Numbering dialog select *Process single parts* and define the: Start value, Increment value, and Method of numbering.
3. Select *Process assemblies* and define the Method of numbering.

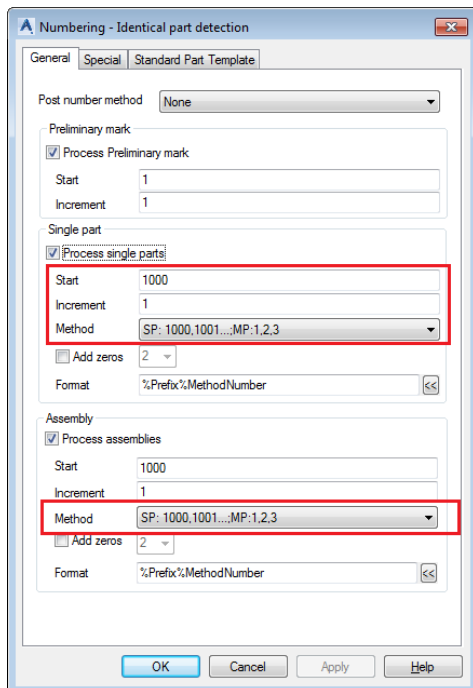

## DRAWING CREATION

The 2D drawings are obtained after the design and numbering of the 3D model.

Advance Steel offers a variety of **drawing styles** for the creation of general arrangement drawings, sections, and shop drawings in various designs.

A **drawing style** is a group of instructions used to create a detail drawing. It defines how the elements are displayed, labeled and dimensioned.

Drawing styles automatically create drawings with a layout configured exactly to the user's requirements. Drawing styles are used similarly to AutoCAD's dimension styles, line styles etc.

The styles contain various settings (displayed parts, view, dimension, labeling, representation, etc.) in database tables (libraries). Styles are available in the **Drawing Styles Manager**  ) → **Output** tab → **Document Manager** panel.

The preferred selection of the existing drawing styles, are displayed in the [Drawing Style Palette](#).

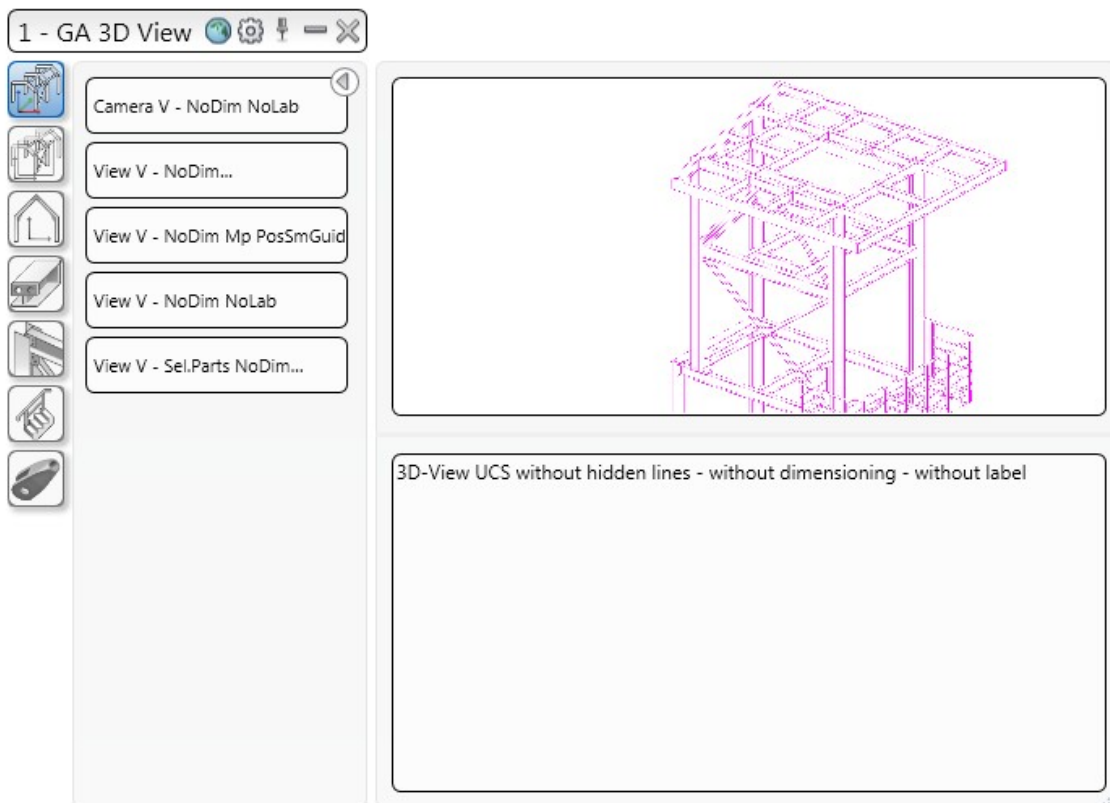

The rules included in a drawing style can be modified. You can also define your own drawing styles.

The drawing style distinguishes between single parts and assemblies and it is used for drawing creation.

The tools for creating drawings are grouped in Quick documents Palettes

There are three Quick Documents palettes:

1. The Drawing Styles palette
2. The Drawing Processes palette
3. The BOM Templates palette

The palettes allow you to quickly browse and use drawing styles and drawing processes for drawing creations as well as list templates for BOM list creations. The categories are represented by intuitive images.

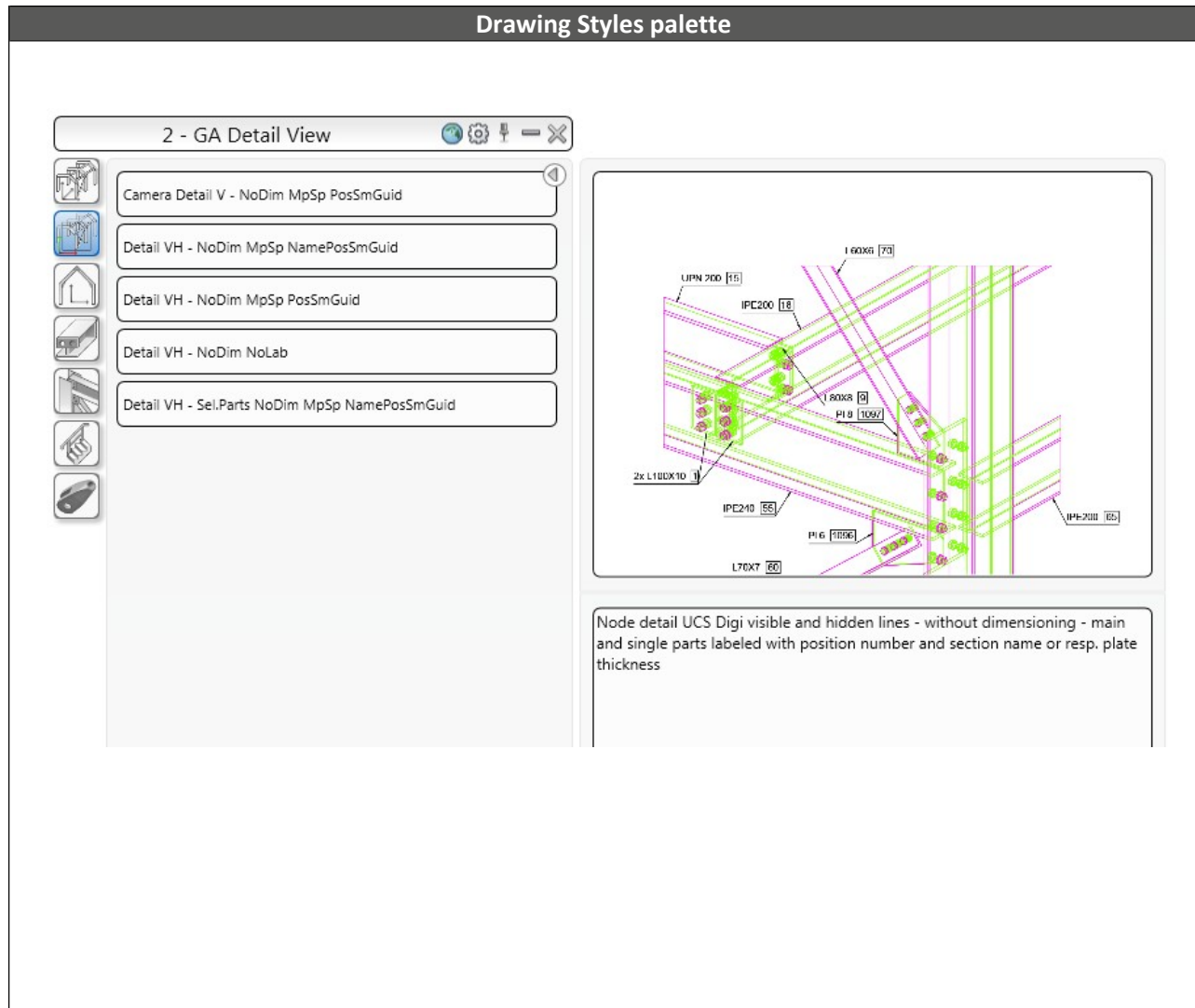

### Drawing Processes palette

Assemblies - Selected ⚙️ 🔍 - ✕

- Selected Assembly - AutoPage
- Selected Assembly Each A3
- Selected Assembly PageFull A0
- Selected Assembly PageFull A1
- Selected Assembly PageFull A2
- Selected Assembly Plate Each A3
- Selected Assembly Plate Each A4
- Selected Assembly Plate PageFull A2

### BOM Templates palette

Assembly List ⚙️ 🔍 - ✕

- Assemblies with attached parts list
- Assembly list
- Assembly list - bolts
- Assembly list - exploded bolts
- Compound beam list
- Loading List
- Shipping list

**AUTODESK ADVANCE STEEL**

Part: 12-01-2014 14:35:14

Client:   
 Project:   
 Designer:   
 Date: 11-Feb-2014

**Company**

ASSEMBLIES WITH ATTACHED PARTS							
Mark	Quantity	Name	Unit	Volume	Total	Volume	All attached parts
	(m)		(m³)	(m³)	(m³)	(m³)	
489	4	C120X25	4230	13100.2	29000.2	0.233	P1141
431	4	RD20	6256	90.613	20162.3	0.273533245	P1000 P1034 P1035 P1037
432	4	RD20	6842	96.813	21788.3	0.283333333	P1000 P1034 P1035 P1037
433	4	RD20	6272	9077.4	20309.2	0.2442224	P1000 P1034 P1035 P1037
434	4	C120X25	2402	11200.2	49200.2	0.233	P1142
435	4	RD20	6815	10620.2	20600.2	0.266222222	P1000 P1034 P1035 P1037
436	4	C120X25	4232	13000.2	29000.2	0.233	P1143
437	4	L120X12	6690	16200.2	23000.2	0.205000	P1031
438	4	Z120X25	4820	3462.2	7202.2	0.206000	P1143
439	4	Z120X25	4185	3177.2	5970.2	0.204600	P1144
440	4	Z120X25	4885	3504.2	6968.2	0.204180	P1145
441	4	C120X25	2402	11200.2	49200.2	0.233	P1143
442	3	C120X25	2940	10800.2	41400.2	0.233	P1143

**Example:** Creating an isometric view.

Save the model prior to starting the drawing creation.

The viewport of the created view depends on the active user coordinate system (UCS). The view direction is against the Z-direction of the UCS.



1. To create an isometric view, click on the **UCS** tool palette and place the UCS in the plane of the screen.

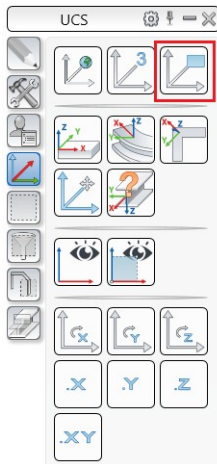

2. On the **Output** tab, **Documents** panel, click .
3. The **Drawing Styles** tool palette appears. In the 2 – GA 3D View category, choose one view type (e.g. 1 – GA 3D View – 2.2 3D View – Model – w/o Labels).

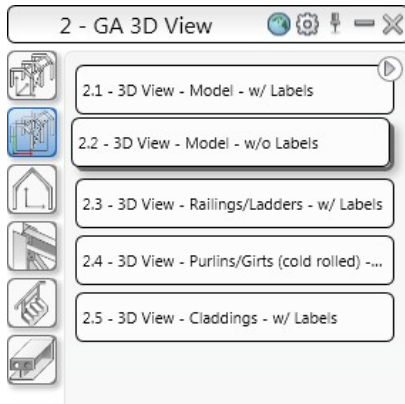

4. The Create detail dialog box appears. From this dialog you can choose between two options to [create the detail](#).

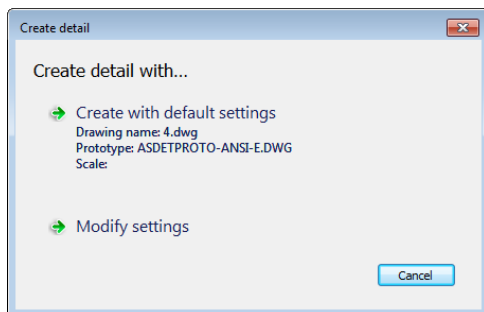

5. Choose Modify settings.
6. In the Select destination file dialog → New drawing tab:
  - a. Name your drawing: e.g. Isometric view.
  - b. Change the scale to 1:20.

- c. Set a path for a separate DWG in which the detail is placed.

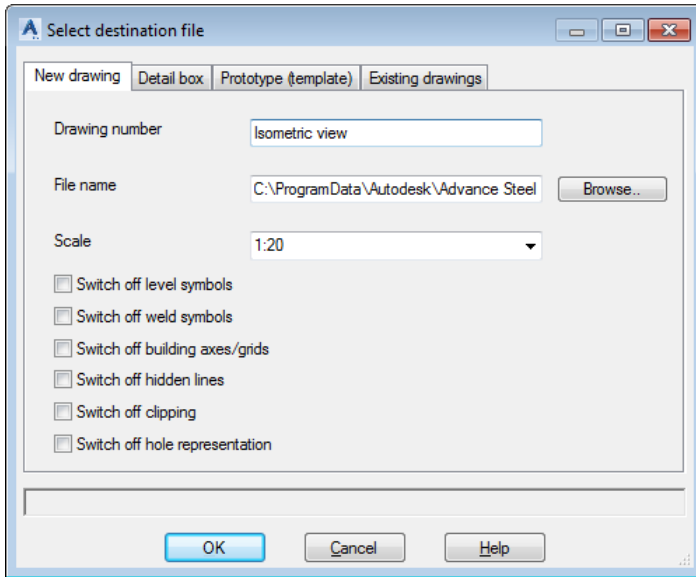

- 7. In the Select destination file dialog → Prototype template tab, select the prototype template:

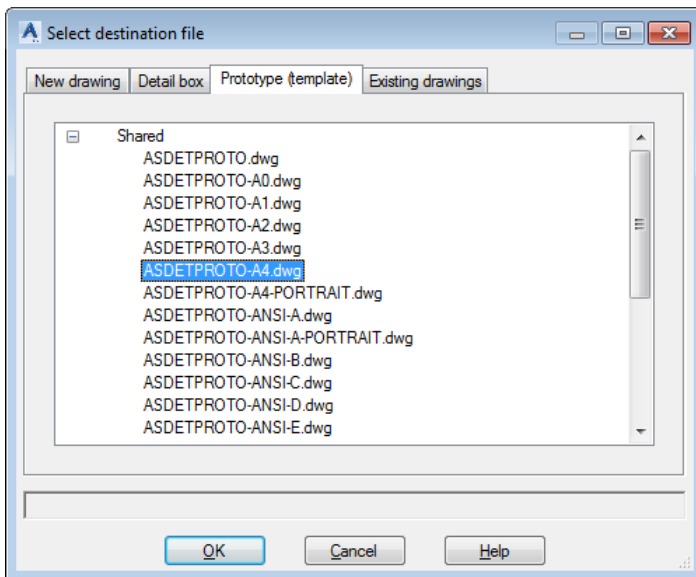

- 8. Click **OK** to close the dialog box.  
The drawing is created and saved as .dwg in the specified path:

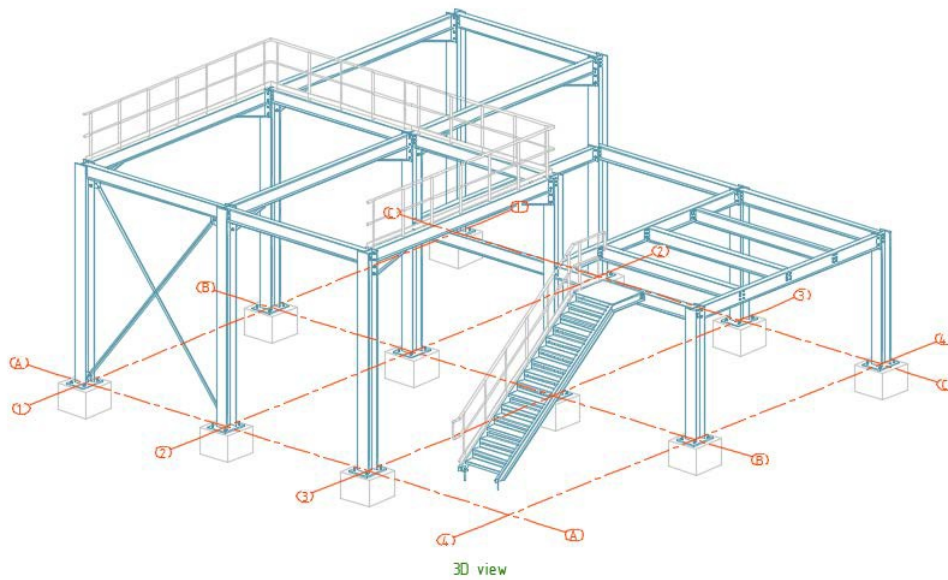
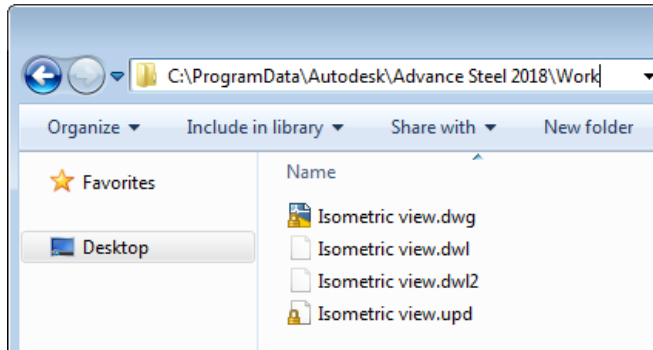

**Example:** Creating an Anchor plan view.

Save the model prior to starting the drawing creation.

The viewport of the created view depends on the active user coordinate system (UCS).

1. The view will be created in the XY plane. Set the UCS to correspond to the view direction, like in the image below:

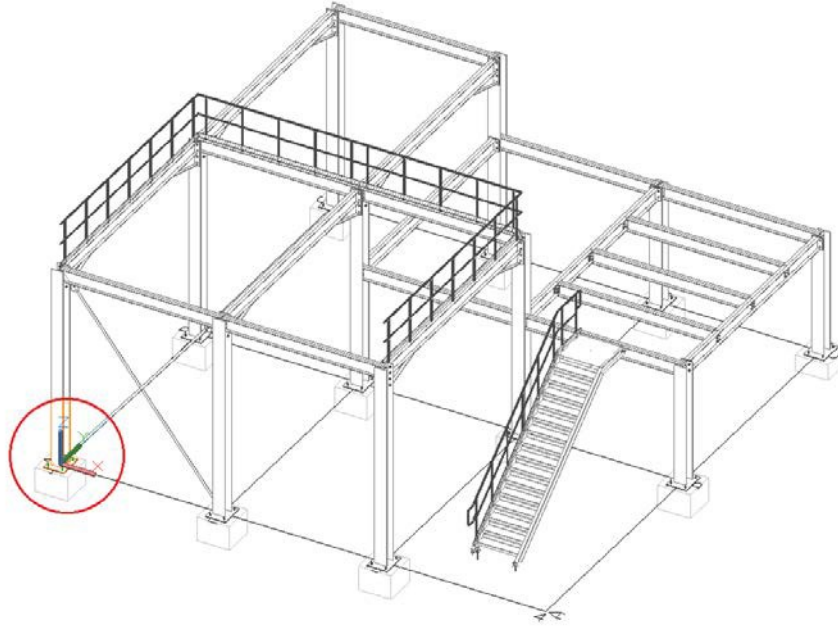

2. Go to the **Output** tab, **Documents** panel, click
3. The **Drawing Styles** tool palette appears. In the *3 – GA Plans/Elevation/Detail* category, choose the view type (e.g. *3.1 – Anchor plan*).



4. The Create detail dialog box appears. From this dialog you can choose between two options to [create the detail](#).

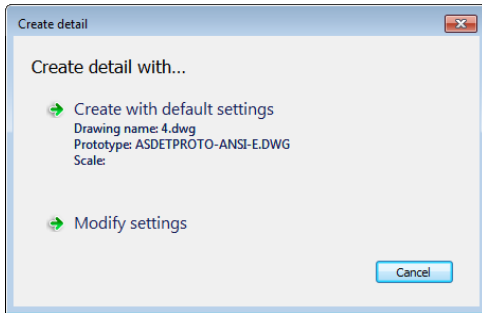

5. Choose Modify settings.
6. In the Select destination file dialog → New drawing tab:
  - a. Name your drawing: e.g. Isometric view.
  - b. Change the scale to 1:20.
  - c. Set a path for a separate DWG in which the detail is placed.
7. In the Select destination file dialog → Prototype template tab, select the prototype template:
8. Click **OK** to close the dialog box.

The drawing is created and saved as .dwg in the specified path:

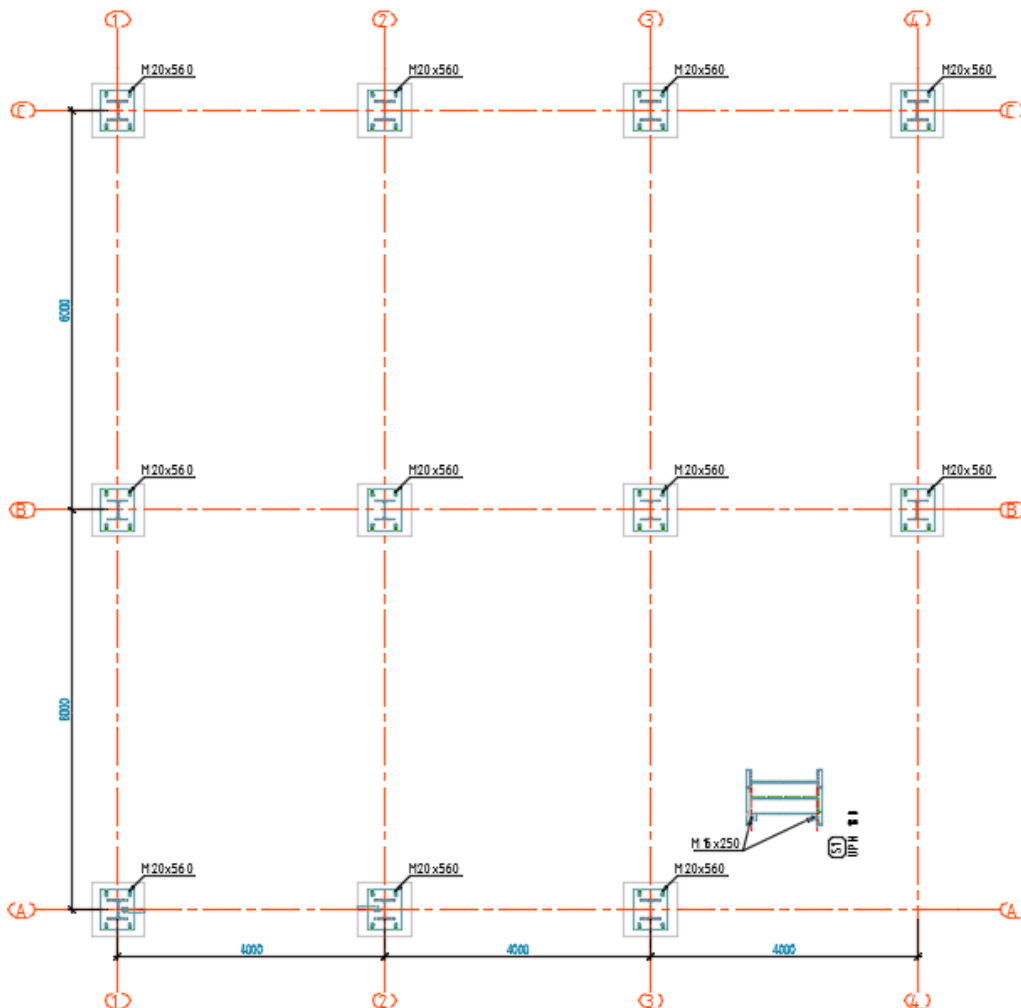



**Example:** Creating an Elevation view.

Save the model prior to starting the drawing creation.

The viewport of the created view depends on the active user coordinate system (UCS).

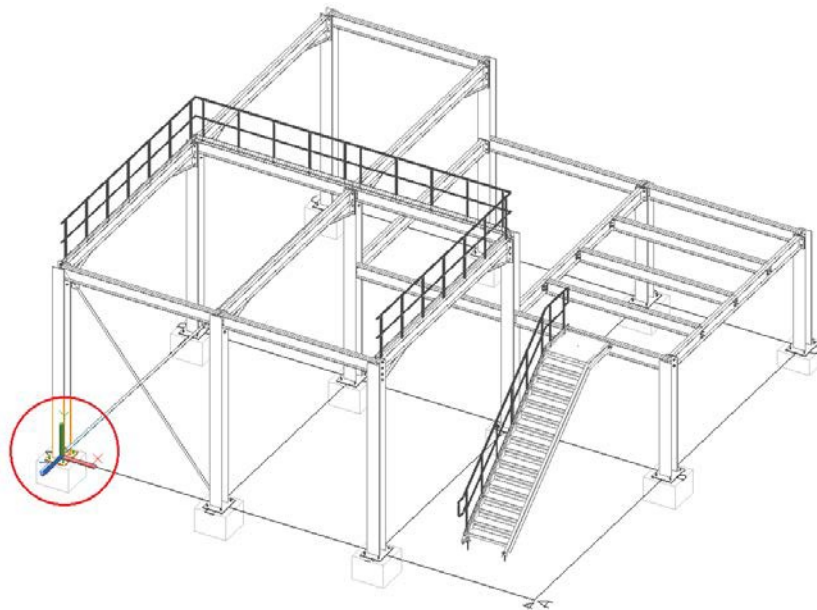
1. The view will be created in the XY plane. Set the UCS to correspond to the view direction, like in the image below:



2. Go to the **Output** tab, **Documents** panel, click  Drawing Styles
3. The **Drawing Styles** tool palette appears. In the 3 – GA Plans/Elevation/Detail category, choose the view type (e.g. 3.3 – Elevation).

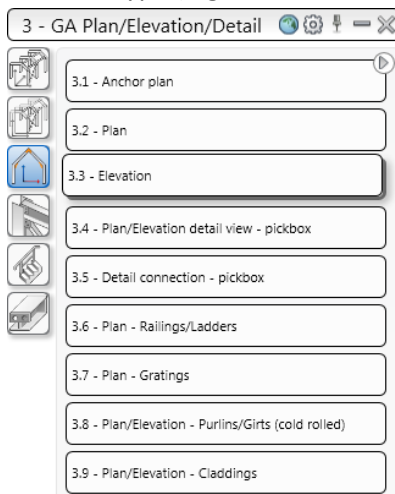

- The Create detail dialog box appears. From this dialog you can choose between two options to [create the detail](#).

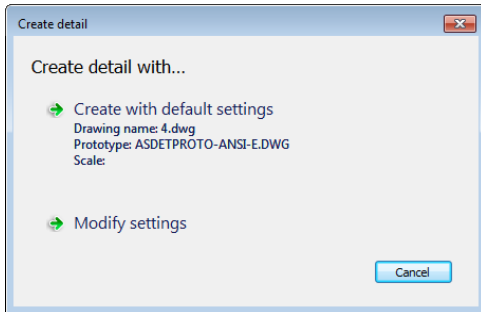

- Choose Modify settings.
- In the Select destination file dialog → New drawing tab:
  - Name your drawing: e.g. Isometric view.
  - Change the scale to 1:20.
  - Set a path for a separate DWG in which the detail is placed.
- In the Select destination file dialog → Prototype template tab, select the prototype template:
- Click **OK** to close the dialog box.

The drawing is created and saved as .dwg in the specified path:

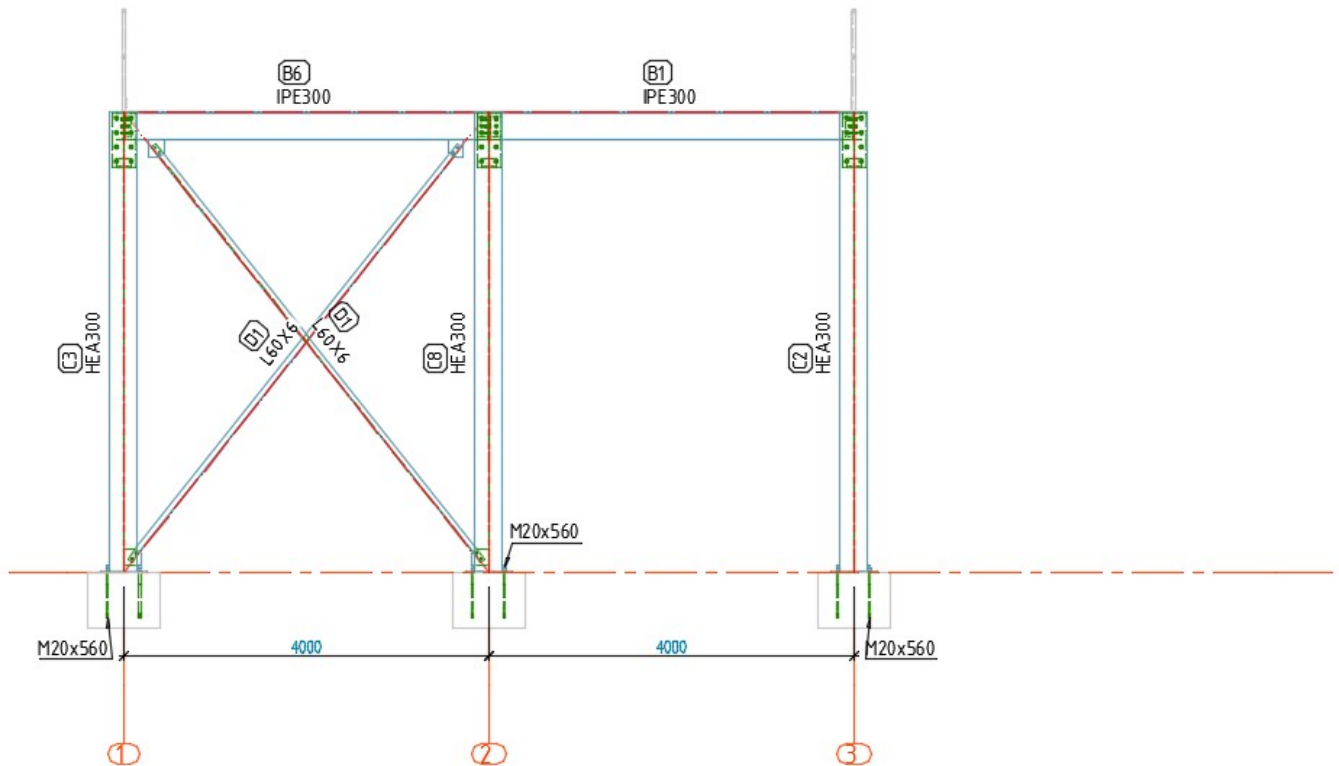



## Drawing management

The **Document Manager** is used to preview, manage and erase the created details in separate drawings (DWGs).

The link between the model and the drawing is managed automatically. Advance automatically detects the details that require updating due to model modifications. The **Document Manager** also controls drawing updates.

The **Document Manager** controls all dependent details and lists all information (e.g., which model drawings have been created and how many). More than one detail can be stored in a single DWG. The **Document Manager** tree structure shows the details that are in each DWG.

### Opening the Document Manager

- On the **Home** tab, **Documents** panel, click 
- On the **Output** tab, **Documents** panel, click 

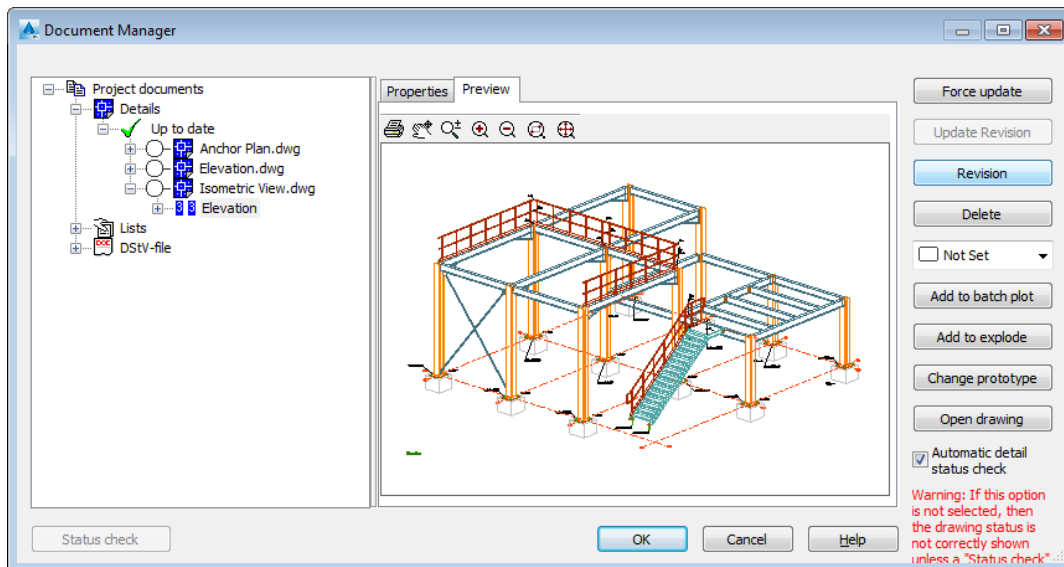

The **Document Manager** lists all the created drawings, bill of materials / structured BOMs and the NC-data created from the model. The documents are displayed on the **Preview** tab.

## Create Shop Drawings

*Example: Creating a single part plate drawing using a drawing style.*

To create a single part detail drawing:

1. On the **Output** tab, **Documents** panel, click 



- The **Drawing Styles** tool palette appears. In the *6 – Singleparts* category, choose one view type (e.g. 6.11 *Sp – Plate*).



- Select the plate from the 3D model and right-click.

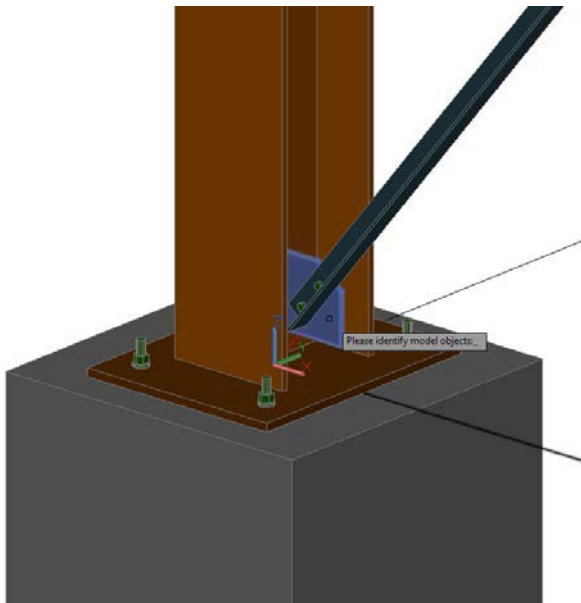

- The Create detail dialog box appears. From this dialog you can choose between two options to [create the detail](#).

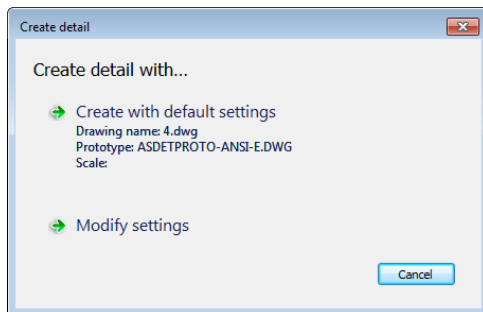

- Choose **Modify settings**.

6. In the Select destination file dialog → New drawing tab:
  - a. Name your drawing: e.g. Isometric view.
  - b. Change the scale to 1:20.
  - c. Set a path for a separate DWG in which the detail is placed.
7. In the Select destination file dialog → Prototype template tab, select the prototype template:
8. Click **OK** to close the dialog box.

The detail drawing is created and saved as a .dwg file in the specified location. You can either open it from the specified location, from the Document manager or by right-clicking on the model object and selecting *Show part detail*.

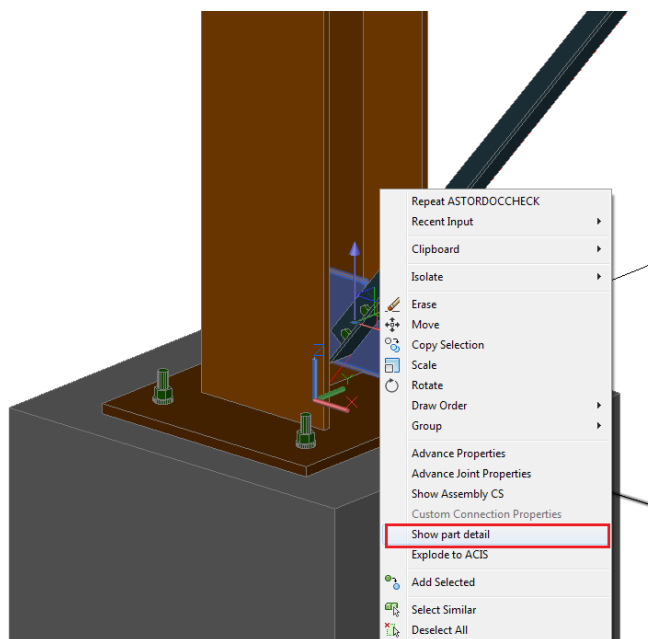
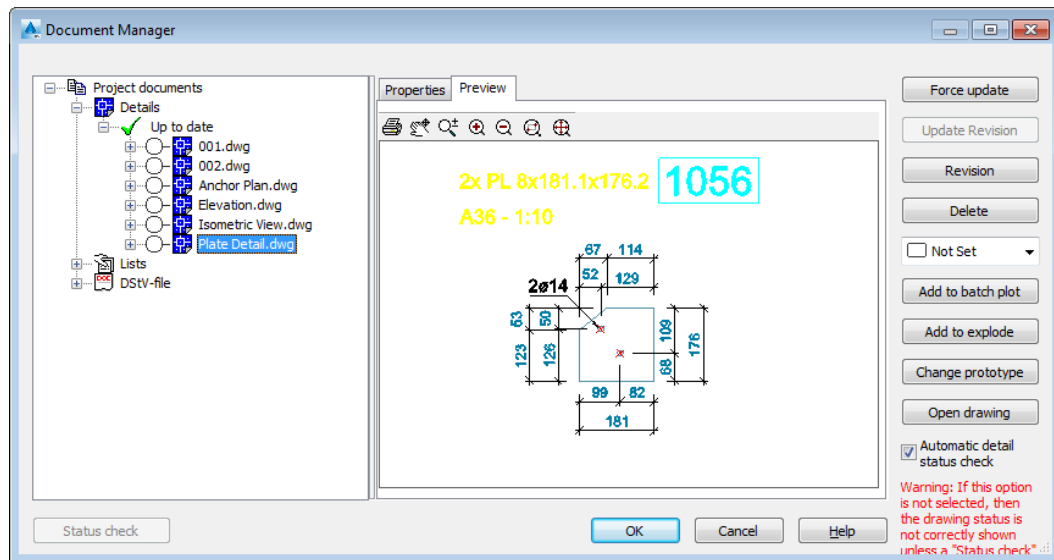

2x PL 8x181.1x176.2

1056

A36 - 1:10

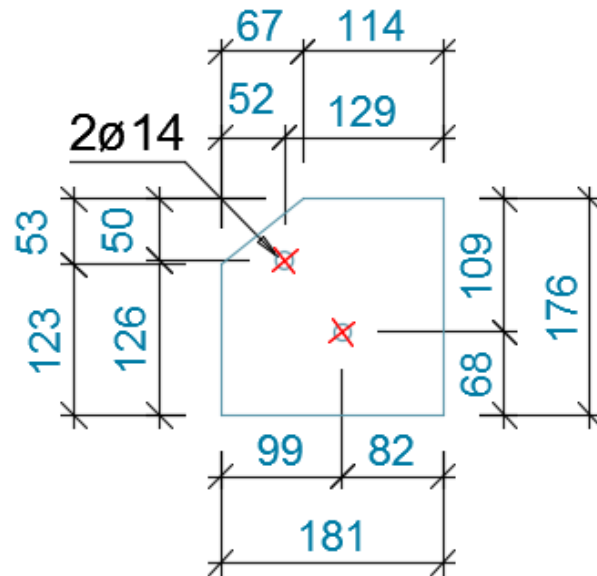

**Example:** Create a shop drawing with all the plates that are single parts, using a drawing process.

To do this:



Drawing  
Processes

1. On the **Output** tab, **Documents** panel, click
2. The **Drawing Processes** tool palette appears. In the 4 - *Singleparts - All* category, choose one view type (e.g. *03- All Singleparts A2 - Fill the sheet*).



3. In the Process properties dialog, from the Selection drop-down, choose All SpPlate and click OK.

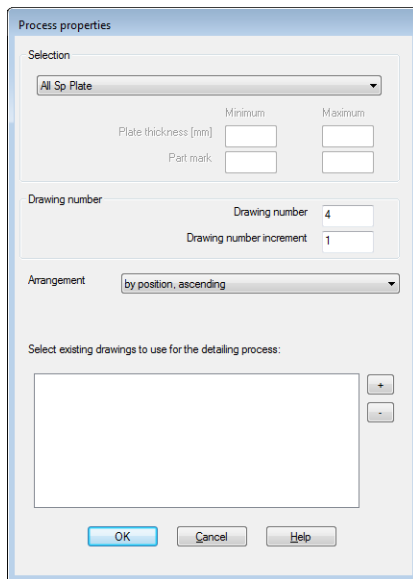

4. The detail drawing is created and saved as a .dwg file in the *Details* folder; in the same location your model is saved. You can either open it from that location, from the Document manager or by right-clicking on any of the detailed model objects (in this case, on any plate) and select *Show part detail*.

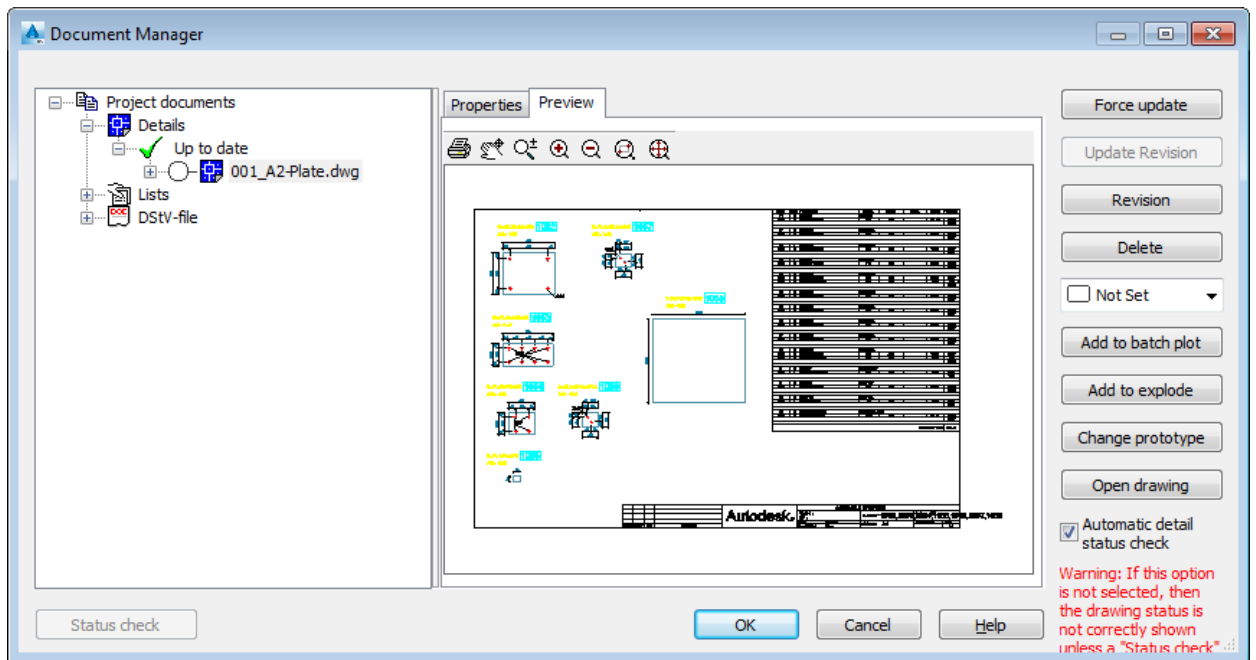
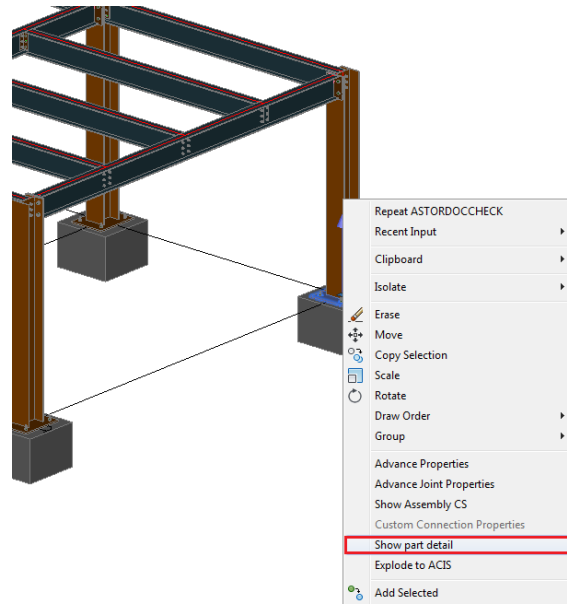

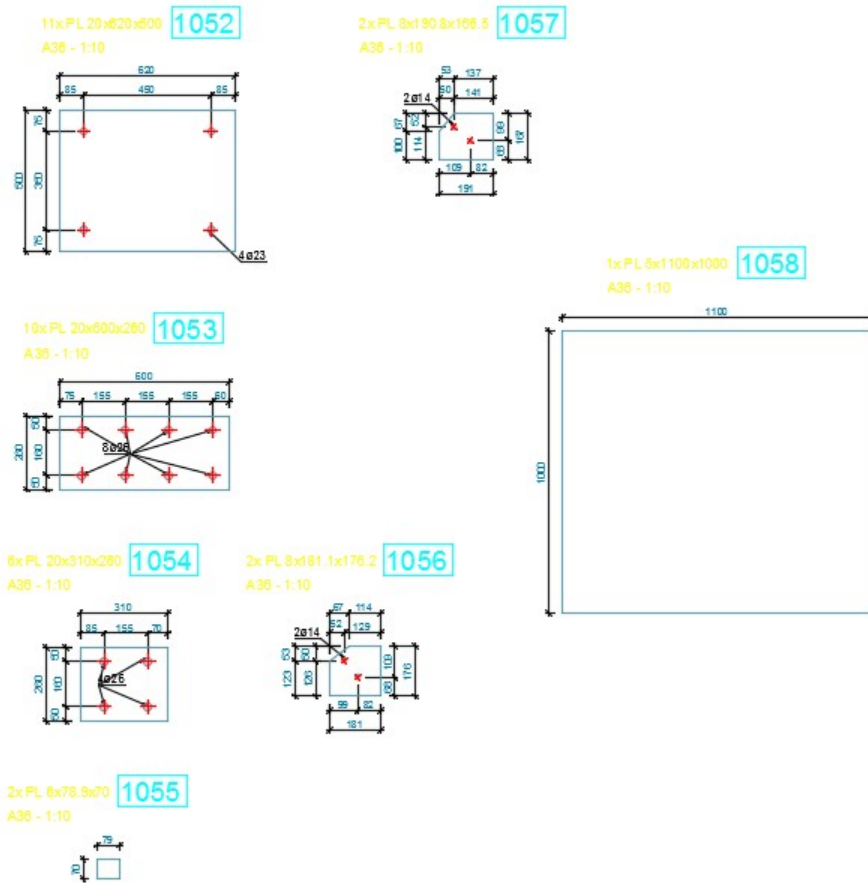

**Note:** If an object is detailed on more than one drawing, you will have more options to choose from in the *Show part detail* contextual menu:

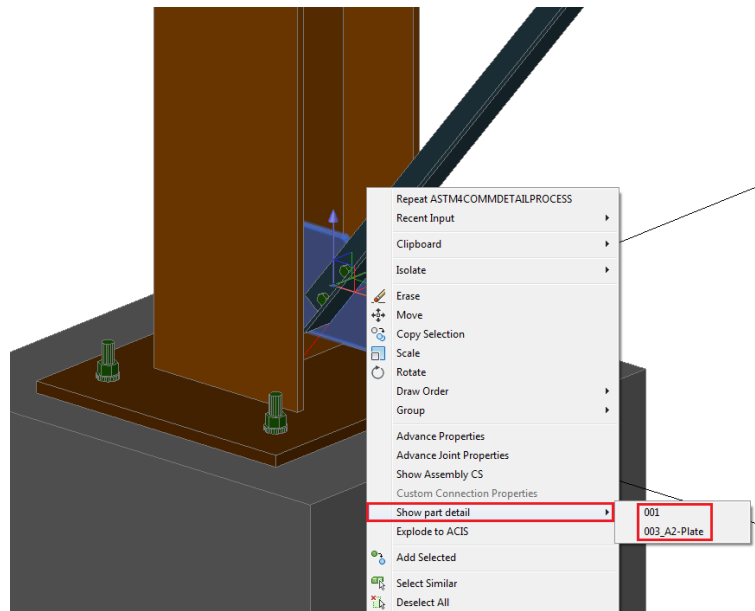

## LIST CREATION

To quickly create a Bill of Material list you need to access the preferred BOM templates, using the Quick Documents - Bill of Material template.

1. You can open the Quick Documents BOM template palette from the **Output** tab



2. To create a list, click on any of the available templates.

**Note:** You can also preselect objects in the model, and the BoM template list will be created only for the objects in the selection.

Mark	Name	Quantity	Quality	Length (mm)	Weight per meter (Kg/m)	Weight of piece (Kg/piece)	Total weight (Kg)	Surface of piece (m2/piece)	Total Surface (m2)	Description
20	IPE300	1	A992	3,969	42.2	167.5	167.5	4.6	4.6	
23	IPE300	1	A992	3,973	42.2	167.7	167.7	4.61	4.61	
25	IPE300	2	A992	5,670	42.2	239.3	478.5	6.58	13.15	
1000	L80X8	6	A992	220	9.7	2.1	12.8	0.07	0.41	
1002	L120X80X10	2	A992	220	15	3.3	6.6	0.09	0.17	
		12					833		22.95	
		12					833		22.95	

Once the list is created, it will be opened in the BOM Viewer and can be saved and registered to the model.

To add or remove BOM templates from the **User** category of BOM templates - Quick Documents palette, you need to set the status of the checkbox associated to the BOM template list in the (BOM Editor) (Output tab → Document Manager tab).

**Note: Change palette content category - Advance / User / Country:** You can switch between categories by clicking the first icon on the palette title bar - the content of the palette will change depending on the chosen category:



The icons differ for each category:

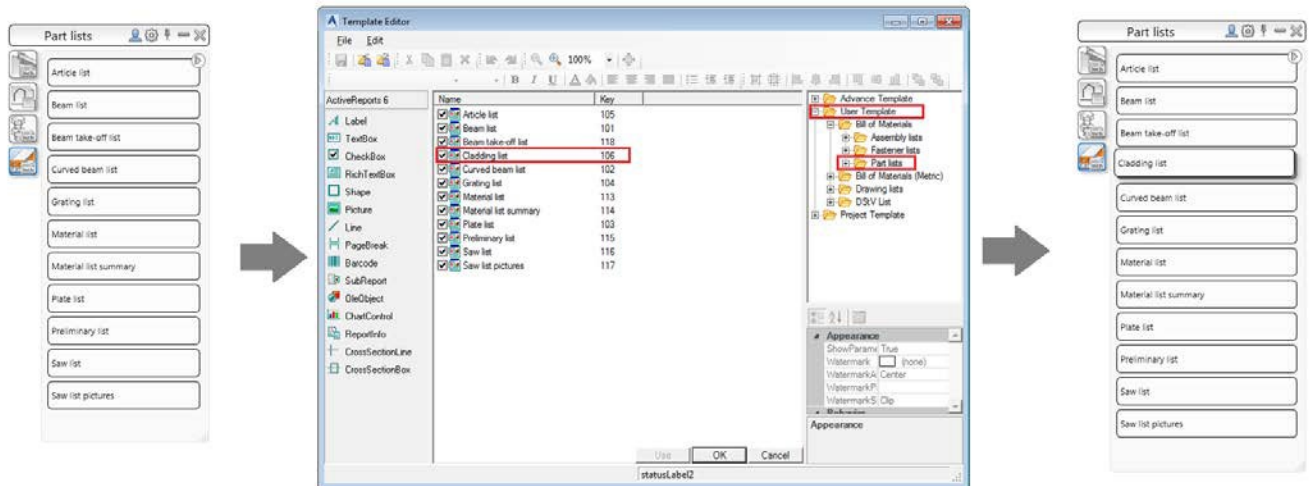
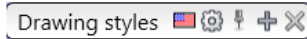

**Example: Create a Material List.**

1. **Output** tab → **Documents** panel → BOM Templates
2. The **BOM Templates** palette appears.



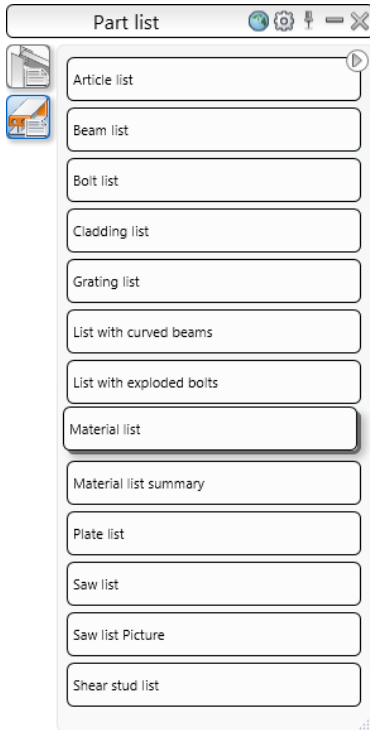

- From the **Part List** category, select **Material List**.

The *Material List* appears. It can be printed, saved, exported to PDF (and other formats) or sent by e-mail using the corresponding icons on the menu bar.

Company:		Client		Job:					
AUTODESK ADVANCE STEEL		DetailDwgExtract.xml		31-Mar-2016					
MATERIAL LIST		Project		Date					
Detailer									
Mark	Name	Quantity	Quality	Length (mm)	Weight of piece (Kg/piece)	Total weight (Kg)	Surface of piece (m2/piece)	Total Surface (m2)	Description
<b>Beams</b>									
1	IPE300	6	A992	3,969	167.5	1,004.9	4.604	27.623	
2	IPE300	5	A992	5,670	239.3	1,196.4	6.577	32.886	
3	HEA300	3	A992	2,980	263.1	789.4	5.126	15.377	
4	IPE300	3	A992	3,973	167.7	503	4.609	13.826	
5	HEA300	2	A992	4,980	439.7	879.5	8.566	17.131	

- Click **Export**. The *Report export* dialog appears displaying the export options.

5. Select an export format from the list.
6. Click **OK**.
7. Save the created BOM file. A file name is requested in a new window. The BOM file is saved as a Report in the ... \[*model folder*]\[*model name*]\BOM\[*BOMfilename*] folder.

## CNC DATA CREATION

Advance Steel produces CNC files (DSTV format) for workshop machinery directly from the 3D model. You can either select one model object or the entire model to create these types of files.

You can access the commands for the CNC data creation from:

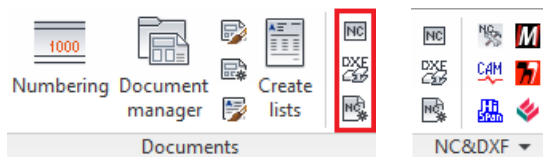

- The **Output** tab → **NC&DXF** panel
- The **Home** tab → **Documents** panel

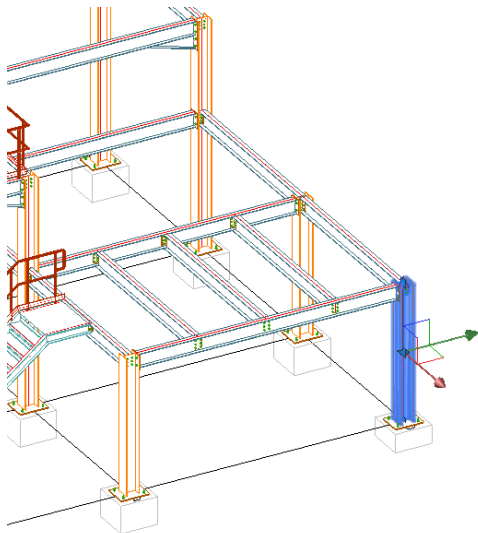

**Example:** Create an NC file for a selected model object.

1. Select a model object.



2. Go to:
  - The **Output** tab → **NC&DXF** panel and click 
  - The **Home** tab → **Documents** panel and click 
3. The NC file is created and is saved in the **DSTV** folder that is automatically created in the same location as you model DWG.

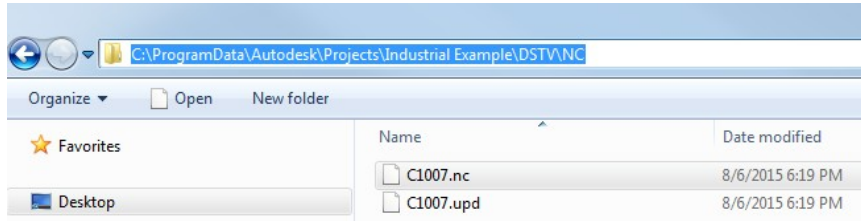
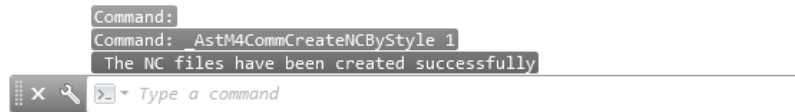

You can also access the NC files, using the **Document Manager**, where you can see a preview of the file.

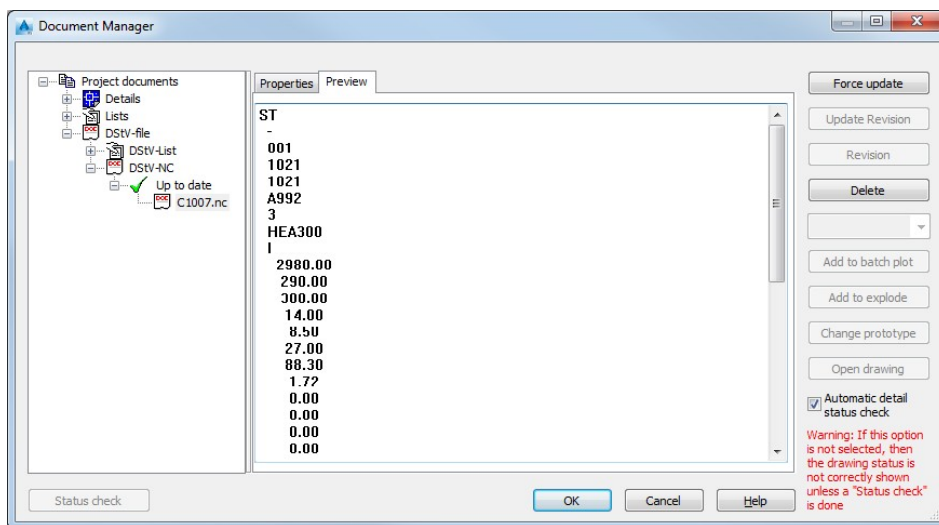

This small exercise was a very simple introduction to Advance Steel. In time, your familiarity, speed, and understanding of the power and versatility of Advance Steel will improve, as you use the software on real projects.

## RECOMMENDED PRACTICES

### Saving the project

1. Create a folder structure to store your projects in correctly, create a projects folder and then create sub folders for each project.  
In that folder store the model which then creates its own relative folder and required sub folders. This keeps all models and databases separate and avoids conflicts.
2. Create an AutoSave folder location and adjust your system to save your automatic backup files to that known location, keep it simple and at the root of the System such as C:\AdvanceSteel\Autosave.
3. Save your model at regular intervals.

4. Use a suitable Name for the Model such as the contract number, project reference or place name. This can be useful later on in the project, as the model name can be listed in the drawing and NC naming and also be linked to the actual file references.

## Modeling

5. Always start your model at 0, 0, 0 in the World Coordinates.
6. Be aware of how you model a beam/section “Right to left” or “left to right”, as this can influence how the front and the back of beam are displayed on an assembly drawing.
7. **Columns** – Always try to model so the Z Axis of the column flange is to the outside face of the building for perimeter columns.
8. **System-line placement** – When modeling horizontal members, roof members, floor beams, etc. always try to have the system line in the top of the profile at the middle of the flange. This affects the assembly drawing dimensioning.

For Columns try to keep it in the center, unless you have a specific need for one column flange face to be at a set location, as this means that if you change section then the change in size goes away from that face. So the flanges still remain in line. This is sometimes used where cladding is applied directly to hot rolled steel flanges.

For purlins and rails, try to keep the system line to the bottom face nearest the supporting beam, as then if the size changes for the rail, the difference goes outwards, rather than altering the hot rolled frame set-out.

Always try to make sure your system lines meet for beams columns, etc. This is like you wire-line in the model and with this it is easy to check the primary position of an object, also the system line is used as the datum for the dimensioning of the Drawings and in other aspects of the modeling.

9. Remember your UCS; this is a vital tool in placement and orientation of objects within the Advance Steel environment.
10. For complex setting out of a building, say radial, always try to have some reference/construction line geometry in the system, create a layer and place it in there, it can be turned off, but it is always there for reference.
11. Before you model a beam type, like poly-beam, or curved beam, consider how you are going to manufacture it and more importantly how you are going to detail it.
  - For simple curves use curved beams, rather than poly beams
  - For complex beams, that may appear too easy to create as poly beams, look at how the original shape line is created. If it is from a series of curves of known radii, model it as a series of curved beams as you will buy it as curves and then weld or joint together. Poly-beams do not lend themselves to being dimensioned as radii; they work on points based upon the references they were created from.

---

*KEEP IT SIMPLE – SIMPLE TO MODEL = SIMPLE TO MAKE.*

---

12. Note the difference between holes and contours, make a decision on how the hole will be produced, drilled or cut out via cutting torch or profiler. This affects drawings and NC

Processing. For drilled holes use the Hole commands. For profiled holes use the Contour commands. The size of the hole makes no difference to how the NC describes it.

13. Assess your project before you start, look at how you are going to build the structure, how it is going to be delivered, where you are starting from, craneage, etc. You can model it in Advance Steel, but you are the one driving it, it goes where you steer it.
14. Try to use Macros where possible for Joints. When using macros, if you create a joint and think you may use it again somewhere, store it in the table with a suitable reference. For example bracings, you can set one up for Flats and one for Tubes, save each to the table and then when inputting bracing you can just select that default.
15. Use the Project Explorer to manage the model structure, set up views so it's easier to work on plan or elevation at a time.
16. Always use model roles, as this defines the prefix in numbering and also has influence with the drawing output. The drawing styles link to the Model roles to set the style within the process.

## Numbering

17. Use the standard numbering rules set in Advance Steel and try to work with those, always let the program to update the model numbering, DO NOT MANUALLY NUMBER UNLESS YOU HAVE TO, this can lead to problems.
18. If the model is not complete, then try numbering using the Lot/Phase option with the box checked. This means that the existing part of the model will have unique numbers. These numbers will not be used elsewhere in the model in later phases. This means you can carry on modeling and then just renumber at a later stage and numbers / items from phase 1 will not alter their numbers.
19. Use the preliminary numbering of the model; adjust the BOM lists to include preliminary numbers. These references never change and can be a good way to track items whose final number has changed. For example, if you pre order curved beams, this reference can be used to track that component.

## Creating drawings

### 20. GA Drawings

Think about what you want before you start; map out how you are going to approach the drawings. For example, floor plans first in level order, from ground up, then Elevations going around the building, Sections through the building, local details of special joints / typical joints, 3D Views of model. Lot phasing 3D views.

Plan it on a piece of paper, make a list, assign the drawing numbers for GAs to follow this pattern, so you may have 5 drawings for plans, 4 for sections, etc.

Think about the SCALE on the paper, if you can combine two elevations onto one drawing, etc.

### 21. Part Drawings

Think about how they are going to be manufactured – in house, sub contracted off profilers, etc. All ordered in at once or in phases. This may change the paper size you choose to produce the drawing on. A3 or A4 single item puts each part on its own drawing, makes it easy to send, each drawing is relative to each part and that part only.

## 22. Assembly Drawings

Think about how they are going to be fabricated – all in one shop, subcontracted to various workshops, in phases, etc. Sometimes it is easier to create single drawings for each assembly, as they can be fitted onto smaller A3 size, most small fabricators only have limited printing facilities, and so sending A1 drawings can mean that they print at a vastly reduced size leading to mistakes, omissions or lots of phone calls to clarify what something is. So set up to smaller sheet to start with a larger scale to show the details clearer.

23. Check the drawings – sometimes things get missed or mixed up in the model, and are not always picked up. Use the drawings to check what is being produced. A quick review can save you time and money in the long run.

## Lists

24. Filter the model to produce lists for required items; use the lists that are set for Curved Beams, plates, beams. Use the list to check the model and that you have done all the drawings and things are not missed.

## NC files

25. If you want only plates of a certain size then use the search filter to find and select them, then create the NC files. You can adjust the naming of the files and details shown on the hard stamp to include things like thickness, number, using the defaults.
26. Be aware of the Defaults in the Management Tools application; there are many settings there that can be adjusted to change the outcome of drawings and modeling, depending on your requirements.
27. When building onto an existing structure this can be modeled in Advance Steel, but you must remember to set that structure so that it is not used for the Drawings or BOMs. These settings are on the **Behavior** tab in the object properties dialog. What this does is to set it so that when the model is numbered, these existing components are numbered but with a negative value and are not considered for drawings or material lists.